

## FOR PROPER AND SAFE USE

Thank you for purchasing a Minolta camera.

A valuable tool for photographers, the Maxxum/Dynax 7 has been designed with precision in mind to help you capture your photographic vision. As you use the Maxxum/Dynax 7, you will find that its performance and reliability compliment your own photographic expertise and raise your skills to a higher level.

The Maxxum/Dynax 7 features a newly developed 9-point AF system with center dual cross-hair sensors to give great flexibility when composing photographs, and the ability to switch between AF and MF, using the AF/MF control button, without changing holding positions.

This is the first camera ever to incorporate a Navigation display which gives easy to understand information on camera operation and Custom functions, available in 5 languages. Combined with the conventional lever and dial controls, the Navigation display provides flexible and clear operation.

This manual has been designed to help you understand the operation of your camera and its functions. Please familiarize yourself with the names of the controls and their locations on the camera, then read the Basic Operation section. Once you've mastered basic operation, move on to the Detailed Operation section to expand your expertise.

This camera is designed to work specifically with lenses and accessories manufactured and distributed by Minolta. Using incompatible accessories with this camera may result in unsatisfactory performance or damage the camera and accessories.

Read and understand all warnings and cautions before using this product.

### **WARNING**

Batteries may become hot or explode due to improper use.

- Use only the batteries specified in this instruction manual.
- Do not install the batteries with the polarity (+/-) reversed.
- Do not subject batteries to fire or high temperatures.
- Do not attempt to recharge, short, or disassemble.
- Do not mix batteries of different types, brands, or ages.
- Tape over lithium battery contacts to avoid short-circuit when disposing of batteries, and follow local regulations for battery disposal.

Keep batteries and other things that could be swallowed away from young children. Contact a doctor immediately if an object is swallowed.

Immediately remove the batteries and discontinue use if...

- the camera is dropped or subjected to an impact in which the interior is exposed.
- the camera emits a strange smell, heat, or smoke.

Do not disassemble. Electric shock may occur if a high voltage circuit inside the camera is touched. Take your camera to a Minolta Service Facility when repairs are required.

Do not look directly at the sun through the viewfinder.

### **CAUTION**

Do not allow a camera lens to point directly at the sun. Fire may occur if sunlight comes to focus on a flammable surface. Replace the lens cap when the product is not being used.

## TABLE OF CONTENTS

Table of Contents .....	4
Name of Parts .....	8
Quick Operation .....	14
<b>BASIC OPERATION</b>	
Batteries .....	17
Loading Film .....	20
Handling the Camera .....	23
Taking Pictures in Full-Auto .....	24
Focusing .....	28
Using the Built-in Flash .....	31
Rewinding the Film .....	33
<b>DETAILED OPERATION</b>	
Navigation Display .....	36
Display Selection .....	37
When Upper Part Turns Black .....	43
Display Brightness/Contrast .....	44
Focusing	
Focus Mode .....	46
AF/MF Control Button .....	50
Focus Area .....	53
AF Illuminator .....	59
Exposure	
P Mode .....	61
A Mode .....	63
S Mode .....	66
M Mode .....	69

Metering	
Selectable Metering .....	74
Exposure Compensation .....	77
Automatic Exposure Lock (AEL) .....	81
Setting the ISO Manually .....	86
Drive	
Continuous .....	88
Self-Timer .....	90
Exposure Bracketing .....	92
Multiple Exposure .....	96
Flash	
Flash Mode Switch .....	99
Red-eye Reduction .....	100
Rear flash Sync .....	101
Slow-shutter Sync .....	102
Flash Compensation .....	103
Flash Bracketing .....	104
Accessory Flash .....	107
Flash Metering .....	108
High Speed Sync .....	110
Wireless/Remote Off-camera Flash .....	112
PC Terminal .....	118
Additional Features	
Date/Time Imprinting .....	120
Eye-Start .....	125
Time Exposures (Bulb) .....	126
Depth-of Field Preview .....	128
Diopter Adjustment .....	130
Setting/Cancelling the Audio .....	131



## NAMES OF PARTS

For information on specific parts, refer to the page numbers shown in parenthesis.

### Camera Body

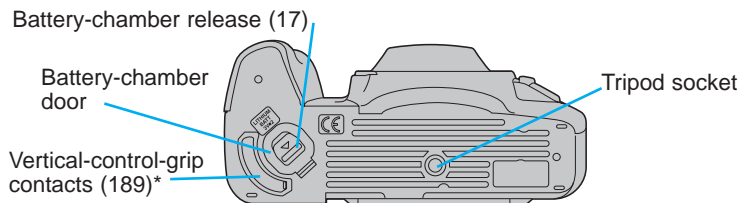
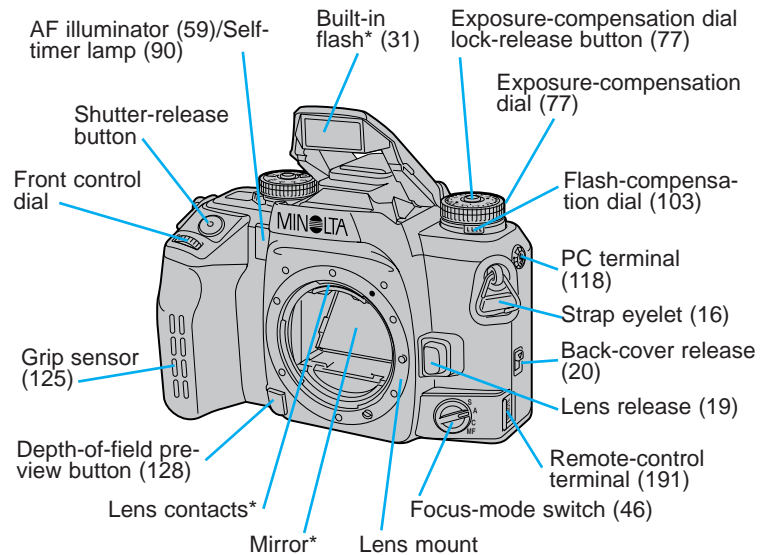

\* Do not touch

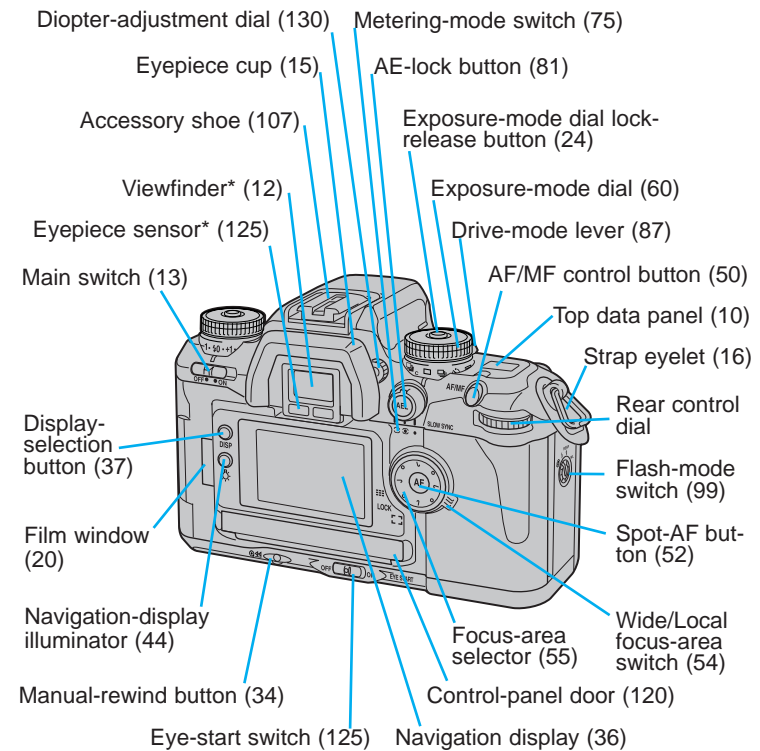

# NAMES OF PARTS

## Control Panel

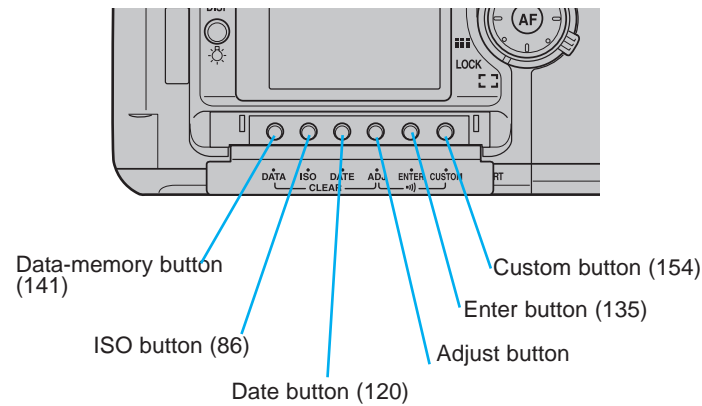

## Top Data Panel

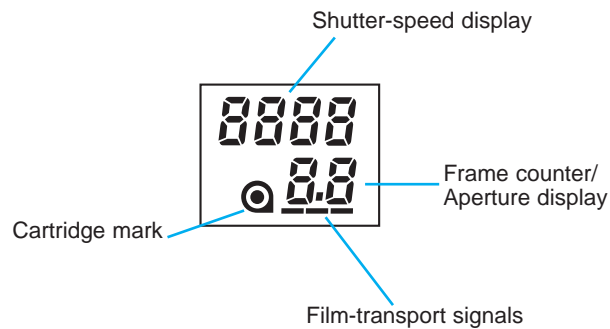

## Navigation Display

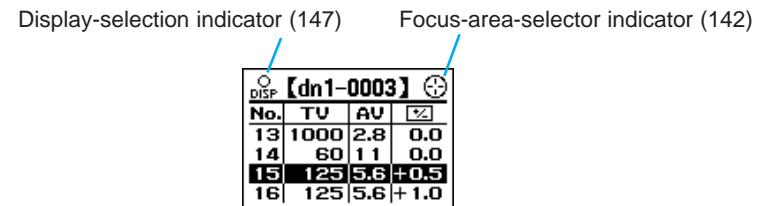
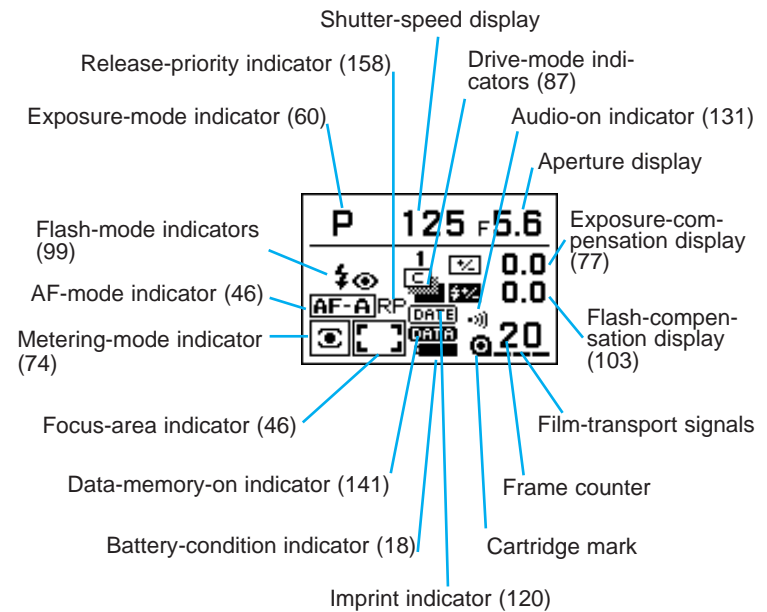

## NAMES OF PARTS

### Viewfinder

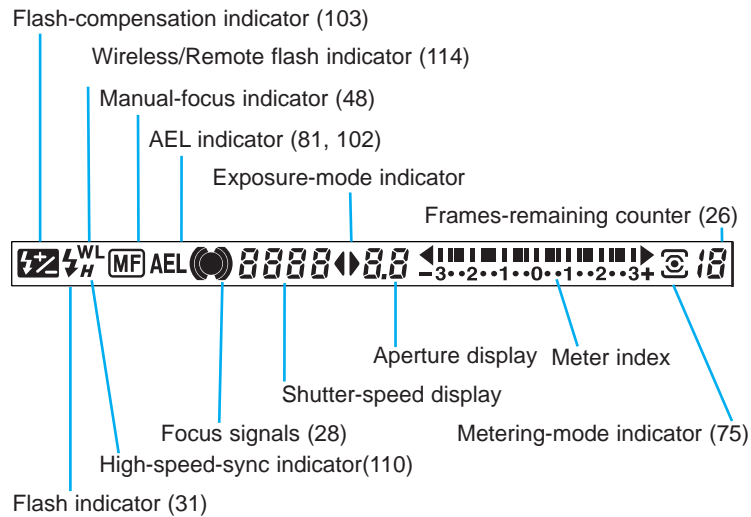
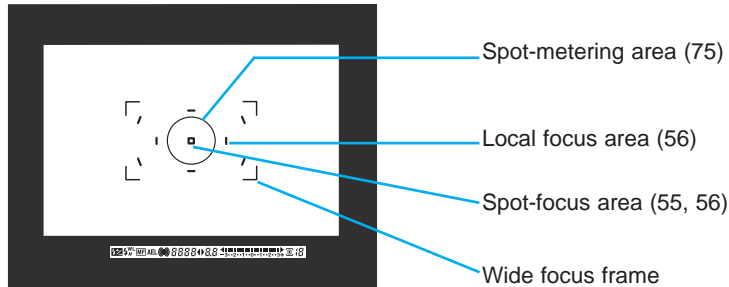

12

## QUICK OPERATION

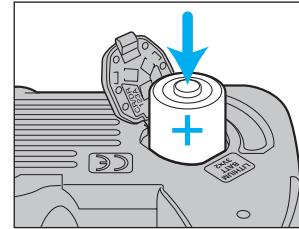

### 1. Insert the batteries.

- The camera uses two CR123A batteries.

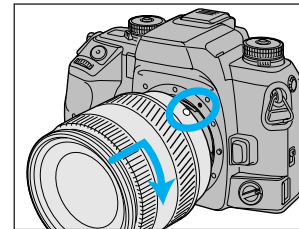

### 2. Attach a lens.

- Align the red marks, then turn it gently clockwise until it clicks.

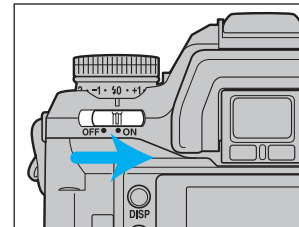

### 3. Turn the camera on.

- Turn the main switch to ON.

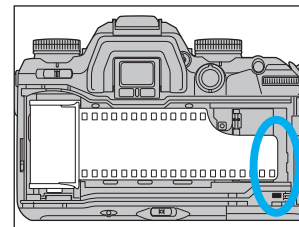

### 4. Load the film

- Align the film-tip with the red mark, then close the back cover.

13

## QUICK OPERATION

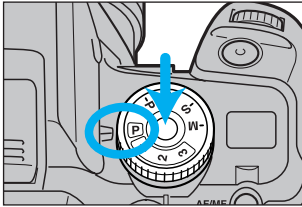

### 5. Set the camera for automatic operation.

- While pressing the exposure-mode dial lock-release button, set the exposure-mode dial to **P**.

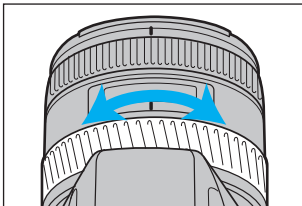

### 6. If using a zoom lens, rotate the zooming ring to frame your subject as desired.



### 7. Center your subject in the focus frame, then press the shutter-release button partway down.

- Focus is set automatically.

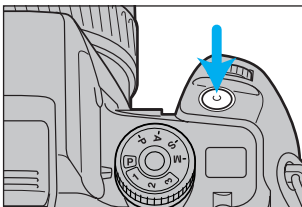

### 8. Take the picture.

- Gently press the shutter release button all the way down.

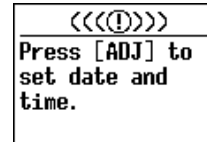

If the camera is turned on and the date and time have not been set, this message appears. See page 121 for instructions for setting the date and time.



The navigation display panel can provide information in any one of five languages (Japanese, English, German, French, or Spanish). To select the language you wish to use, see Custom 35 (p. 187).

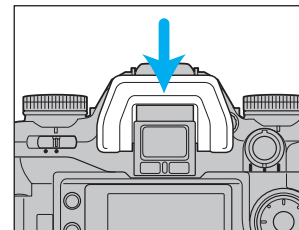

Attach the eyepiece cup for comfortable viewing.

# BASIC OPERATION

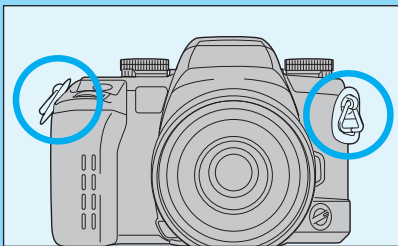

Attach the strap as shown.

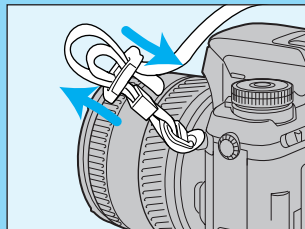
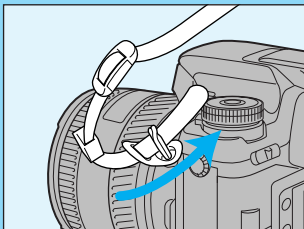

- If you have Remote Cord RC-1000S or RC 1000L, you can use the cord holder on the strap. Attach the strap so that the holder comes to the side of the remote-control terminal (p. 191).

## BATTERIES

### Installing the Batteries

Your camera uses two 3V CR123A lithium batteries to supply power for all camera operations.

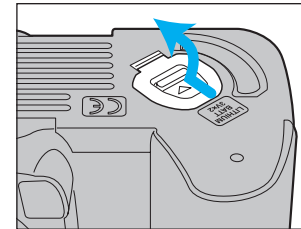

1. Turn the main switch off. Then slide the battery chamber release as shown, and open the door.

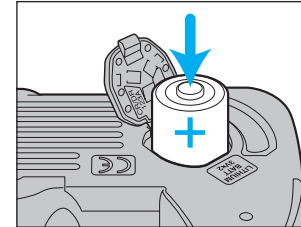

2. Insert the batteries as indicated by the + and - marks.
3. Close the battery-chamber door.

(((!)))

Press [ADJ] to set date and time.

If the camera's batteries are removed for a long period of time, the date and time settings will be lost. When this happens, this message appears, and the date/time information will not be imprinted. See page 121 for instructions for setting the date and time.

## BATTERIES

### Battery Condition Indicators

The battery condition indicator displays the power status of the batteries when the main switch is set to ON.

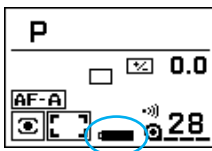

#### Full-battery indicator

Power is sufficient for all camera operations.

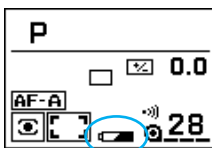

#### Half-battery indicator

Power is low, but all functions are operational. Keep a fresh battery handy.

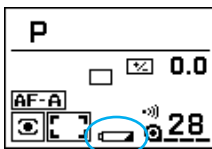

#### Low-battery indicator

Power is extremely low. The batteries will need to be replaced soon. Flash recycling time may be slow.

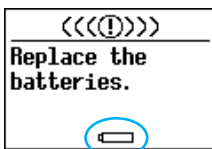

#### Batteries are exhausted

Power is insufficient for camera operation. Replace the batteries.

- If no display appears, power is too low for the camera to operate. Replace the batteries or make sure they have been inserted correctly.

## LENS

### Attaching the Lens

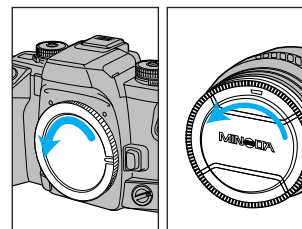

1. Remove the body and rear lens caps.

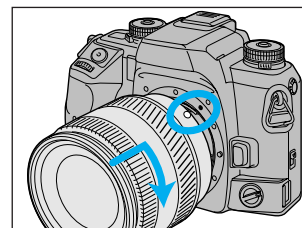

2. Align the red bead on the lens with the red dot on the camera's lens mount. Press the lens against the lens mount, and turn the lens clockwise until it clicks in the locked position.

- Do not press the lens release when mounting the lens. The lens will not couple properly.

### Removing the Lens

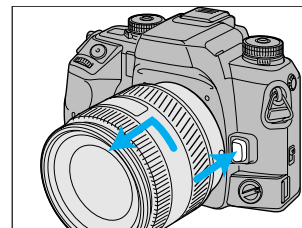

1. While pressing the lens release, turn the lens counter-clockwise until it stops.

2. Remove the lens and replace the caps, or attach another lens.

#### Caution

- Do not force the lens if it does not turn smoothly.
- Do not touch the inside of the camera, especially the lens contacts and mirror.

## LOADING FILM

Remove and discard the protective cover on the film gate before loading film for the first time.

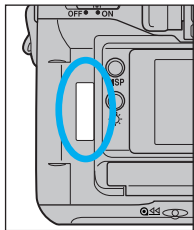

Check the film window before loading film. If film is already loaded, refer to Manual Rewind on page 34 to remove a partially exposed roll.

- Load film in the shade to reduce the chances of fogging the film.

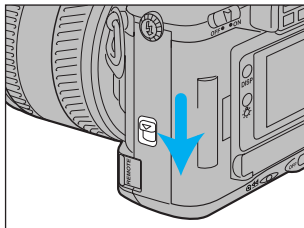

**1. Slide the back-cover release and open the back cover.**

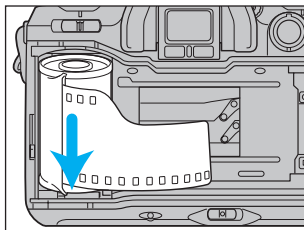

**2. Insert film cartridge into the film chamber.**

- Refer to page 159 to reload a partially exposed roll.

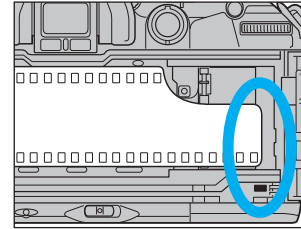

**3. Extend the leader between the guide rails to the index mark.**

- If the film tip extends beyond the index mark, push the excess film back into the cartridge.



**4. Close the back cover.**

- The camera automatically advances the film to the first frame. 1 will appear in the frame counter.

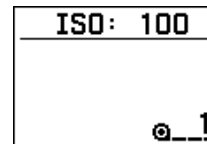

- The ISO is shown in the navigation display for 5 seconds after loading.

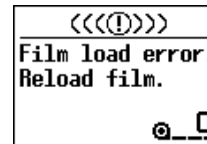

- If loading was unsuccessful, this message appears in the navigation display. Repeat steps 1-4.

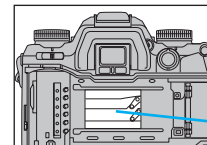

The shutter curtain's precision design makes it extremely sensitive to pressure. Never touch it with your fingers or the film tip.

shutter curtain

## LOADING FILM

- Once the film is loaded, the back cover will lock until film rewinding is complete, preventing accidental opening.
- ISO is set automatically if DX-coded film is loaded. See page 86 for changing ISO manually.
- Non-DX-coded film is automatically rewound at the end of the roll or after 36 exposures.
- Non-DX-coded film is set to the ISO from the previous roll. Refer to page 86 to set the film speed manually.
- Do not use Polaroid Instant 35mm film. Winding problems may occur.
- Do not use infrared film in this camera. The camera's frame counter sensor will fog infrared film.

## HANDLING THE CAMERA

### Holding the Camera



Grip the camera firmly with your right hand, while supporting the lens with your left. Keep your elbows at your side and your feet shoulder-width apart to hold the camera steady. Keep the camera strap around your neck or wrist in the event you accidentally drop the camera.

- Do not touch the end of the lens barrel while taking a picture.
- Do not block the AF illuminator.
- Use a tripod when using slow shutter speeds or a telephoto lens.
- When taking vertically aligned photographs, the use of the vertical control grip, allows for easy access to all camera functions.

### Pressing the Shutter-Release Button

Press the shutter-release button partway down to activate the camera's autofocus and auto-exposure systems. Gently press the shutter-release button all the way down to take the picture.

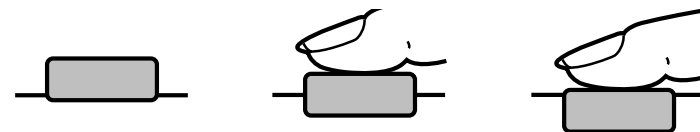

## **P** TAKING PICTURES IN FULL-AUTO

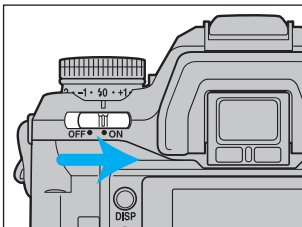

1. Turn the main switch to ON.

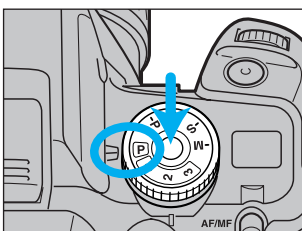

2. While pressing the exposure-mode dial lock-release button, set the exposure-mode dial to **P** full-auto.



Full-auto is shown in the display. When the upper part is black, as shown, the position of the dials and levers may not match the actual camera control.

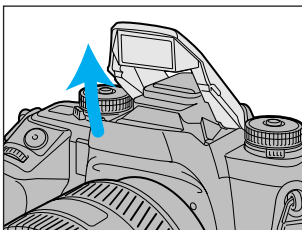

3. Raise the built-in flash.

- If the flash is raised, it will automatically fire when needed.
- For details on using the built-in flash, see page 31.

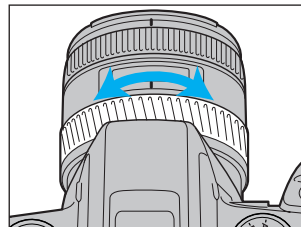

4. If using a zoom lens, rotate the zooming ring to frame your subject as desired.



5. Center your subject in the focus frame.



6. Press the shutter-release button partway down.

- Focus will be set automatically.
- Audio sounds and the local focus area LED appears briefly indicating the focus area selected by the camera.

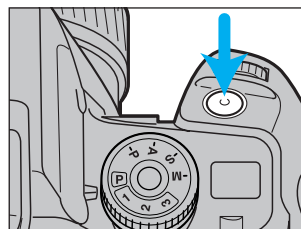

7. When ● or (●) appears in the viewfinder, press the shutter-release button all the way down to take the picture.

- Use focus lock (p.29) if your subject is outside the focus frame.

## **P** TAKING PICTURES IN FULL-AUTO



- The number of frames remaining is displayed in the viewfinder for the last 19 frames on the roll. This countdown does not appear for non-DX-coded film.

- You can not take more pictures on a roll than what is stated on the film cartridge.
- Audio sound can be canceled (p 131).

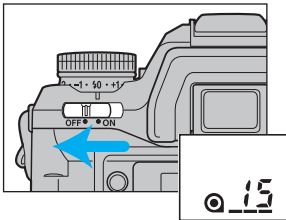

- After taking picture, turn the camera off.
- After the camera is turned off, the frame counter remains displayed in the top data panel, but not in the rear navigation display.
- The frame counter in the top data panel disappears when the main switch is turned on.

### Full-Auto Basic Settings

When the exposure-mode dial is set to **P**, the functions in the table below are reset to the full-auto mode, and locked in order not to be changed.

Function	Full-Auto Settings	Page No.
Exposure mode	Program (P)	61
Metering mode	14-segment honeycomb-pattern	74
Flash mode	Autoflash, if the built-in flash is up. (Pre-flash for red-eye reduction fires in accordance with the position of the flash-mode switch).	99
Focus mode	AF-A, Autofocus priority	46
AF area	Wide focus area	54
Drive mode	Single frame advance	87

26

Function	Full-Auto Settings	Page No.
Exposure compensation	+/- 0.0EV	77
Flash compensation	+/- 0.0EV	103
PA/PS creative program mode	Cleared	62
Flash-metering method	ADI (Advanced Distance Integration) 4-segment metering	108

- When the exposure-mode dial is set to **P**, the functions in the table above are reset to full-auto mode, and locked in order not to be changed. However, if Custom 24-2 (p. 178) is selected, these settings can be changed after the dial is set to **P**.
- The following items will not be reset when the exposure-mode dial is set to **P**. Additional changes to these can be made after selecting **P**.
  - Whether built-in flash fires or not
  - Red-eye reduction
  - Date and time imprinting
  - Data memory
  - Eye-start
  - ISO setting
  - Audio sound setting
  - Custom function settings, except for custom functions 1, 20, 21, 22 and 23.





27

# FOCUSING

## Focus Signals



The following signals appear in the viewfinder to indicate the focus status when the shutter-release button is pressed partway down.

- **Focus is confirmed.**
-  Continuous autofocus – **Focus is confirmed.**
-  Continuous autofocus – **Lens focusing.** Shutter is locked.
-  (Blinks) **Focus cannot be confirmed** – Shutter is locked.
-  Subject is too close or is one of the special focus situations described on page 30.

- In the above chart, the shutter is locked when the lens is focusing or when focus cannot be confirmed. To change so that the shutter can be released, even if focus has not been confirmed, select Custom1-2.
- If eye-start is on, it is possible to activate focus by bringing the camera to your eye. See eye-start for more information (p. 125).

## Focus Lock



Use focus lock when your subject is outside the focus frame or when autofocus is difficult to confirm.

- The focus lock method described on this page, is used for stationary subjects. For moving subjects, see page 47 .

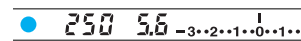
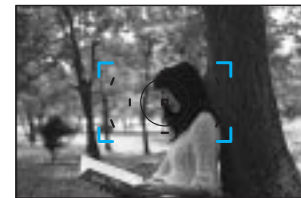

**1. Center your subject in the focus frame, then press the shutter-release button partway down.**

- ● appears in the viewfinder when focus is confirmed.
- Focus lock also locks the exposure settings when 14 segment honey-comb-pattern metering is selected (p. 74).

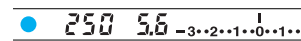
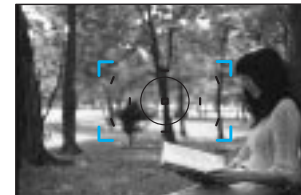

**2. Continue to hold the shutter-release button partway down while you compose your picture.**

**3. Press the shutter-release button the rest of the way down to take the picture.**

- If the shutter-release button is raised partway up, focus lock will not be cancelled. If you want the camera to refocus, remove your finger from the shutter-release button.
- Focus lock is not possible unless ● appears in the viewfinder.

## FOCUSING

### Special Focus Situations

The camera may not be able to focus in situations like those described below. When the focus signal blinks, use focus lock (p. 29) or manual focus (p. 48). See page 28 for an explanation of the focus signals.

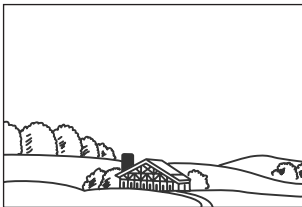

If the subject within the focus frame is very bright, or low in contrast.

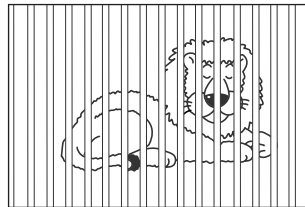

If two subjects at different distances overlap in the focus frame.

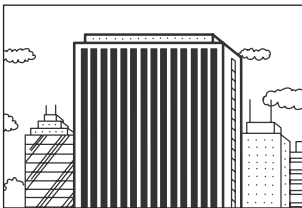

If a subject composed of alternating light and dark lines completely fills the focus frame.

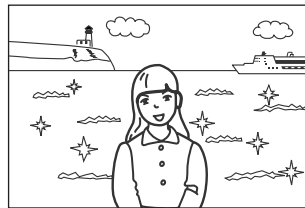

If your subject is near a very bright object or area.

## USING THE BUILT-IN FLASH

The built-in flash provides coverage for focal lengths as wide as 24mm.

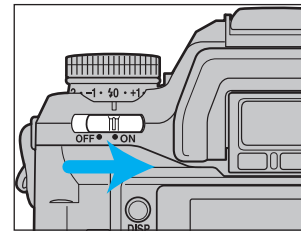

1. Turn the main switch to ON and set the exposure-mode dial to P.

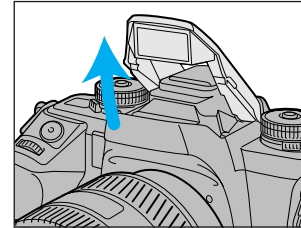

2. Raise the built-in flash.
3. Press the shutter-release button to take the picture.

- When the exposure mode dial is set to P, the built-in flash will fire only when necessary.
- For red-eye reduction, turn the flash-mode switch to the red-eye reduction position.
- To cancel the flash, push the flash down.

### Flash Signals



The following signals appear in the viewfinder to indicate the flash status when the shutter-release button is pressed partway down.



Flash is charged.



(Blinks) Previous exposure was correct.

## USING THE BUILT-IN FLASH

### Flash Range

The range of the built-in flash depends on the speed of the film and the selected aperture. Make sure your subject is within the flash range specified in the table below.

Aperture	ISO 100	ISO 200	ISO 400
f/2.8	1.0 ~ 4.3m (3.3 ~ 14.1 ft.)	1.0 ~ 6.1m (3.3 ~ 20.0 ft.)	1.0 ~ 8.6m (3.3 ~ 28.2 ft.)
f/3.5	1.0 ~ 3.4m (3.3 ~ 11.2 ft.)	1.0 ~ 4.8m (3.3 ~ 15.7 ft.)	1.0 ~ 6.8m (3.3 ~ 22.3 ft.)
f/4	1.0 ~ 3.0m (3.3 ~ 9.8 ft.)	1.0 ~ 4.2m (3.3 ~ 13.8 ft.)	1.0 ~ 6.0m (3.3 ~ 19.7 ft.)
f/5.6	1.0 ~ 2.1m (3.3 ~ 6.9 ft.)	1.0 ~ 3.0m (3.3 ~ 9.8 ft.)	1.0 ~ 4.3m (3.3 ~ 14.1 ft.)

### Lens Shadowing

Lens shadowing occurs when the lens or lens hood blocks part of the output from the built-in flash. Lens shadowing appears as semi-circular shaded area at the bottom (horizontal) or side (vertical) of your image.

- Make sure you are at least 1m (3.3 ft.) from your subject when using the built-in flash.
- Remove the lens hood before using the built-in flash.
- Lens shadowing may occur with the following lenses at shorter focal lengths.
 

AF Zoom 17-35mm f/3.5G	AF Zoom 28-70mm f/2.8G
AF Zoom 28-85mm f/3.5-4.5	AF Zoom 28-135mm f/4-4.5
- The built-in flash can not be used with the following lenses:
 

AF 300mm f/2.8 (APO tele)	AF 600mm f/4 (APO tele)
AF 300mm f/4 (APO tele)	

## REWINDING THE FILM

### Automatic Rewind

The film is automatically rewound after the last frame is exposed.

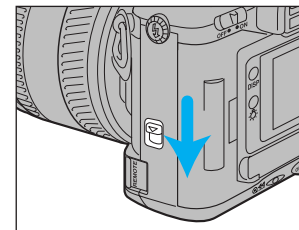
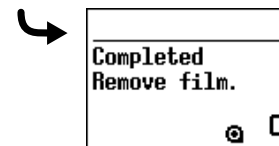
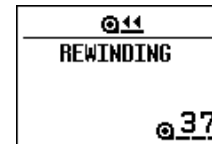

1. Wait until the film is completely rewound.

- Do not open the back cover until this message appears in the navigation display. Never use force.

2. When the film is completely rewound, open the back cover and remove the film.

- If the manual rewind button is pressed while the film is rewinding, the rewind speed will change.

## REWINDING THE FILM

### Manual Rewind

Use manual rewind to rewind the film before the roll is finished.

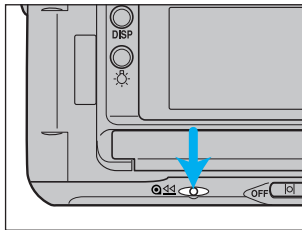

**Gently press the manual-rewind button.**

- Use a blunt object. A sharp object may cause damage.

#### Custom Function Notes

Custom 2, 3 and 12 refer to the rewinding of film.

Custom 2 - Automatic (1) or manually initiated (2) rewind start.

Custom 3 - Rewind the leader into the cartridge (1) or leave the leader out (2).

Custom 12 - Fast (1) or slow/silent (2) rewind.

# DETAILED OPERATION

Once you have mastered the basic operation, you can move on to the Detailed Operation section to expand your expertise. Read those pages pertaining to the areas of your interest and need.

## DETAILED OPERATION

Navigation Display .....	36
Focusing .....	45
Exposure .....	60
Metering .....	73
Drive .....	87
Flash.....	98
Additional Features.....	119
Memory Functions.....	132
Data Memory.....	140
Custom Functions .....	153

# NAVIGATION DISPLAY

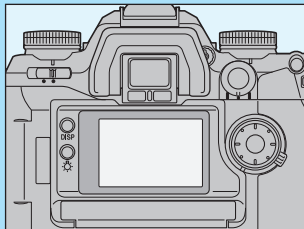

Your camera uses the navigation display (a dot-matrix presentation in the large LCD panel on the back of the camera) to provide you with useful photographic information.

- Only general information is included in this section. Please refer to each specific section for more detailed information.
- Display will be slow in cold weather, but it normalizes when it warms up.
- If the camera is not operated for more than 1 hour, with the main switch on, the display will disappear. Press the shutter-release button partway down, or turn the main switch off and then back on, for the display to re-appear.

## DISPLAY SELECTION

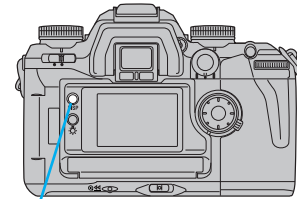

Display-selection button

When the camera is first turned on, the detailed display is shown. Pressing the display-selection button causes the displays to change as follows:

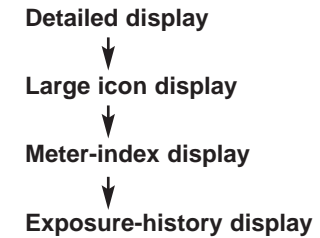

- The horizontal detailed display is used for explanations throughout this manual.

# DISPLAY SELECTION

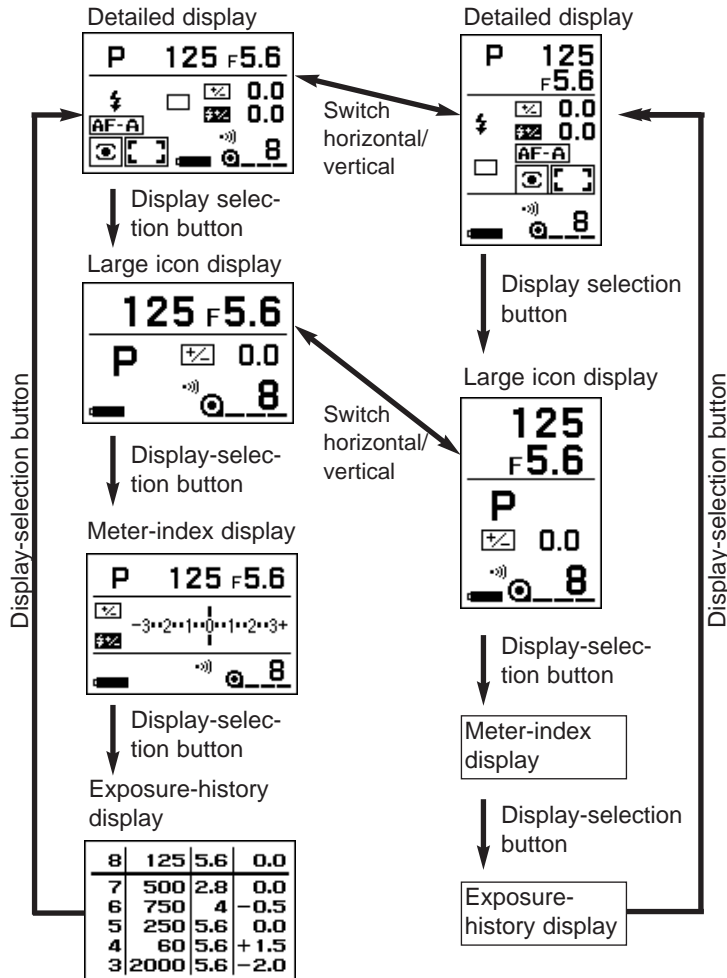

## Detailed Display

The detailed display shows all the settings.

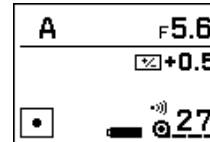

- By selecting Custom 27-2 (p. 182), you can show only those settings which differ from the standard settings.

## Large Icon Display

For easier viewing of only a few items, select the large-icon display option.

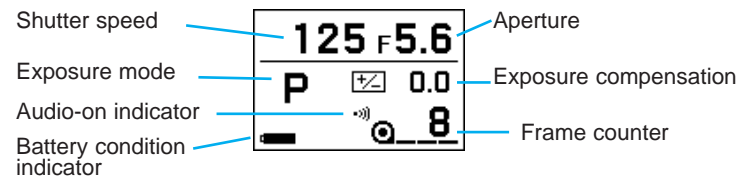

- To cancel this display, select Custom 29-2 (p. 184).

## DISPLAY SELECTION

### Meter-Index Display

The meter index display shows the values of compensation and bracketing that you have selected. The lower part shows compensation/bracketing with flash. The upper part of the display is shown in both the viewfinder and the navigation display.

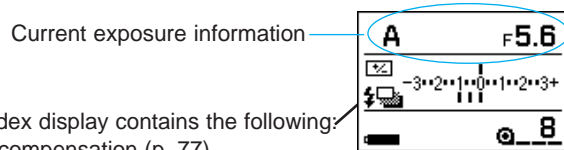

The metering index display contains the following:

- Exposure compensation (p. 77)
- Flash compensation (p. 103)
- Metered manual value (p. 71)
- Exposure bracketing (p. 92)
- Flash bracketing (p. 104)
- When AEL appears, EV difference between the AE locked and current exposure value. (p. 83)

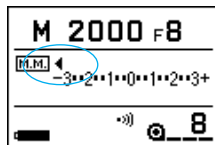

• ◀ or ▶ appears if the index is more than +/- 3.0 EV.

- To cancel this display, select Custom 30-2 (p. 185).

### Exposure-History Display

The exposure data for the next frame appears in the top of the display, followed by the those of the last 5 frames.

Top left part usually shows frame counter, but changes when multiple exposure drive mode or STF is selected:

**M1**, **M2**...: When in multiple-exposure mode.

**STF**: When in STF mode.

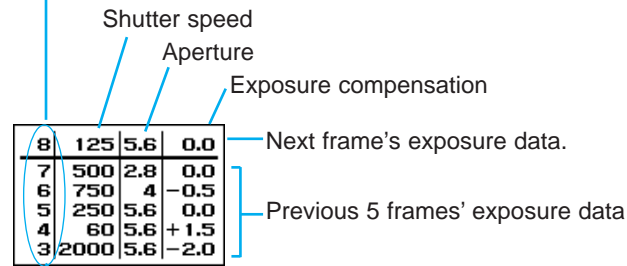

- Displays present frame count.
- If there is no film in the camera, there will be no display.

- In this display, the imprint indicator **DATE**, data memory ON indicator **DATA** and the audio indicator will not appear.
- After 5 exposures, whenever the shutter is released, the oldest exposure data is deleted.
- For multiple exposures, the history shows the data of every exposure.
- Exposure-history is cleared by the replacement of the battery.
- To cancel this display, select Custom 31-2 (p. 185).

## DISPLAY SELECTION

### Vertical Display

The horizontal/vertical operation automatically changes the orientation of the navigation display, when the camera's position is changed to a vertical or horizontal position.

- Only the detailed and large-icon display are able to be displayed vertically. All others remain in the horizontal orientation.
- If you want the display to remain in the horizontal orientation, regardless of the camera's position, choose Custom 32-2 (p. 186).

### Operation Display

The operation display appears whenever you operate a camera dial or function that is not currently on the display. The new settings will appear for 5 seconds. When the detailed display has been selected, the operation display will not appear.

Example below shows the large icon display. When continuous (high-speed) drive mode is selected, the display changes to the operation display showing the new change, and then returns to the large icon display 5 seconds later.

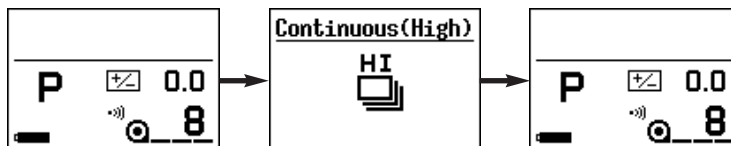

- During the display's 5 second period, pressing the shutter-release button partway down will return the display to the previous display.
- To cancel this display, select Custom 28-2 (p. 184).

## DISPLAY (WHEN UPPER PART TURNS BLACK)

When the exposure-mode dial is turned to P, A, S, or M, the upper part of the display remains normal. But when **P**, 1, 2, or 3 is selected, the upper part turns black.

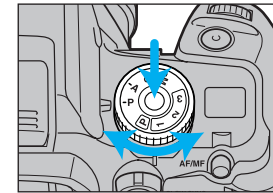

When the dial is set to full-auto **P** or to one of the memory settings, the upper part of the display turns black and the position of the dials and levers may not match the actual camera control. The camera recalls the full-auto settings or the settings saved in the selected memory function, and these are correctly shown on the navigation display.

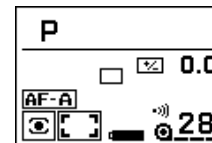

Example 1: Exposure-mode dial set to P. (Normal)



Example 2: Exposure-mode dial set to **P**, full-auto mode. Top part of display has turned black.

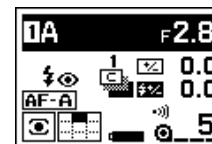

Example 3: Exposure-mode dial set to 1. (memory setting). Top part of display has turned black.

## DISPLAY BRIGHTNESS AND CONTRAST

### Display Illumination

If desired, the display can be illuminated.

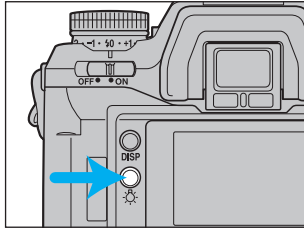

**Press the navigation display illuminator.**

- The display illuminator shuts off approximately 5 seconds after the last camera operation.
- If the button is pressed again before the 5 seconds, it will shut off.

### Display Contrast

The contrast level of the display is adjustable.

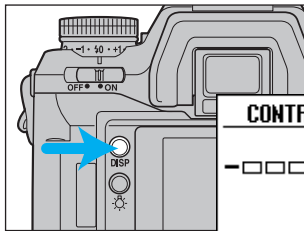

**1. Press the display selection button for 3 seconds to select the contrast set display.**

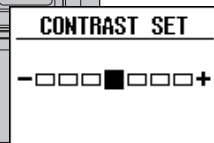

- The contrast set display appears.

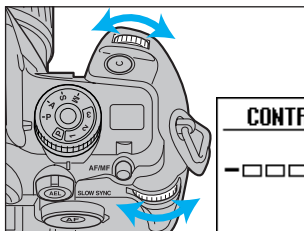

**2. Turn either the front or rear-control dial to adjust the contrast intensity.**

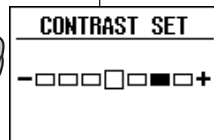

- Turning the dial in the + direction increases the intensity.

- The contrast display will disappear when the shutter-release button is pressed partway down.

## FOCUSING

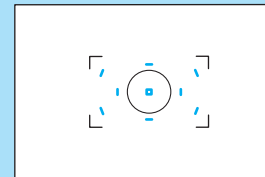

Your camera features complete focus control, utilizing a newly developed 9-point autofocus system with center dual cross-hair sensors to give great flexibility when composing photographs, and the ability to switch between AF and MF using the AF/MF control button without changing holding positions.

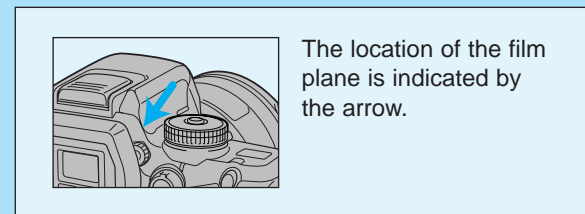

The location of the film plane is indicated by the arrow.

## FOCUS MODE

Your camera has 3 autofocus modes plus manual focus. With the camera set to other than **P**, you can select one of the following modes.

- Automatic autofocus (A)
- Continuous autofocus (C)
- Single-shot autofocus (S)
- Manual focus (MF)

### Automatic Autofocus (A)

Designed to work well in almost any situation, automatic autofocus is especially suited to moving subjects that stop suddenly. When the subject is moving, continuous autofocus is set. When not moving, single-shot autofocus is set.

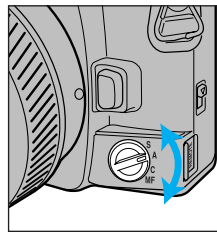

1. Turn the focus-mode switch to **A**.
2. Press the shutter-release button partway down to activate autofocus.

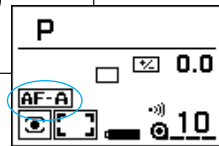

- The camera will continue to focus as long as the subject is moving, then lock focus when the subject is still.
- **AF-A** appears in the display.

- When the exposure-mode dial is set to **P**, automatic autofocus is set.
- Using custom functions, you can choose to select direct manual focus (DMF) when the focus-mode switch is in the A position (p. 176).

### Continuous Autofocus (C)

Use continuous autofocus when shooting sporting events or when you know the subject will be in constant motion.

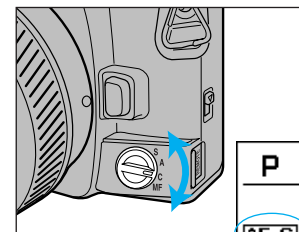

1. Turn focus-mode switch to **C**.
2. Press the shutter-release button partway down to activate autofocus.

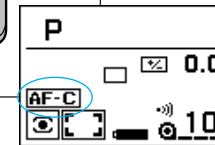

- **AF-C** appears in the display.

- The camera continues to focus as long as the shutter-release button is pressed partway down.
- Audio doesn't sound and the local focus area LED doesn't appear in the viewfinder in this mode.

### Single-Shot Autofocus (S)

Use single-shot AF when photographing non-moving subjects or to lock focus on subjects outside the focus area.



## FOCUS MODE

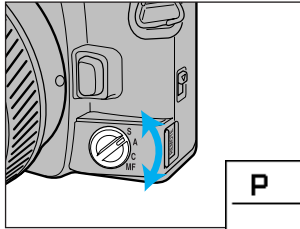

1. Turn the focus-mode switch to **S**.
2. Press the shutter-release button partway down to activate autofocus.

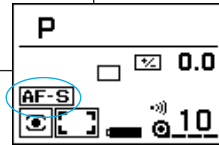

- **AF-S** appears in the display.

- Once confirmed, focus remains locked until your finger is removed from the shutter-release button.

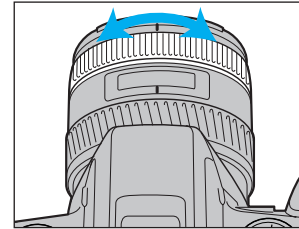

2. Turn the focusing ring until your subject appears sharp and focused.

- **●** appears in the viewfinder when the subject in the focus frame is in focus.
- Even though manual focus has been selected, it is possible to utilize autofocus by pressing the AF/MF control button (p. 51).
- When the focus ring doesn't turn smoothly (for example when using a teleconverter) see page 52.
- This camera uses distance information, even when in manual focus mode, to obtain a proper exposure. In order to get precise information, the focus position is at infinity when the camera's main switch is moved to the ON position.

### Manual Focus (MF)

Focus the lens manually when autofocus is not suitable and focus lock is not possible. The autofocus system will monitor focus and indicate when a subject in the focus frame is in focus.

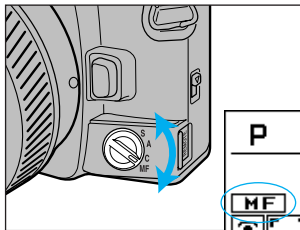

1. Turn the focus-mode switch to **MF**.

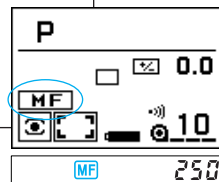

- **MF** is displayed in both the viewfinder and navigation display.

### AF Power Zoom and xi Series Lenses

Pull and turn the zoom ring until your subject appears sharp.

## AF/MF CONTROL BUTTON

The AF/MF control button is located on the back allowing an instant selection of focus mode with the right thumb without changing the holding position.

- AF/MF control button cannot be used with xi series and AF Power zoom lenses.

### AF to MF

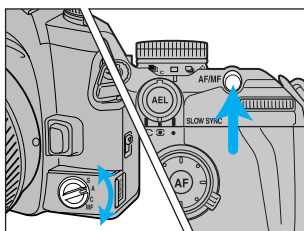

**In AF mode (focus-mode switch set to C, A, or S), the AF mode is switched to MF mode while pressing the AF/MF control button.**

- Turn the focusing ring while pressing the AF/MF control button.

- **MF** will appear in the viewfinder while the AF/MF control button is pressed. However, the AF-mode indicator in the navigation display (AF-A, AF-C, AF-S) doesn't change.
- If you don't change the focus, the focus will remain locked while pressing the AF/MF control button.
- If Custom 9-2 is selected, autofocus and manual focus are automatically switched over by every push of the AF/MF control button, instead of while pressing the AF/MF control button (p. 167).

### MF to AF

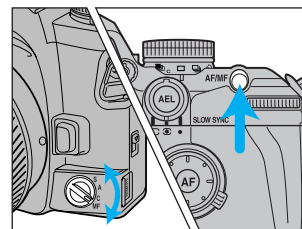

**In MF mode (focus-mode switch set to MF), when the AF/MF control button is pressed, the MF mode is switched to AF-S, autofocus is activated, and then focus is locked.**

- When you release the AF/MF control button, the camera returns to MF mode, and now re-focusing is possible using the focusing ring.
- When the AF/MF control button is pressed, the camera will also meter the subject.
- While pressing the AF/MF control button, **MF** disappears in the viewfinder, but will remain in the navigation display.
- If Custom 9-2 is selected, autofocus and manual focus are automatically switched over by every push of the AF/MF control button, instead of while pressing the AF/MF control button (p. 167).

## FOCUS AREA

### Smooth Focusing

The advance total focus control system has many advantages over the conventional system. However, when used with certain lenses, such as a teleconverter, the lens may have a heavier feel than conventional models, when focusing manually. If desired, users can temporarily select a conventional manual focus operation.

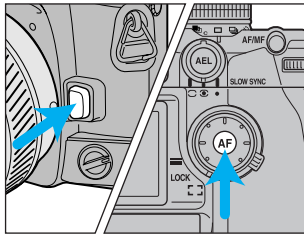

1. Set the focus-mode switch to MF.
2. Simultaneously press the spot-AF button and lens release.
3. Release your finger from the lens release first, then from the spot-AF button.

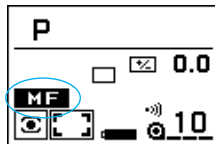

- **MF** appears instead of the normal **MF**.

- The AF/MF control button is inactive when the reversed **MF** appears on the navigation display.
- Some benefits, such as improved exposure metering and flash-metering accuracy in manual focus, will now be the same as with a conventional camera.
- 14-segment honeycomb-pattern (p. 74) is changed to metering similar to center-weighted average when this option is selected.
- To return to the usual camera operation, set the focus-mode switch to C, A, or S, or set the exposure-mode dial to **P** full-auto.
- AF Power zoom and xi Series lenses cannot be used.

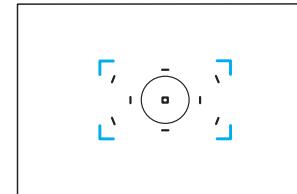

Wide focus area

The camera's standard focus mode, wide focus area, covers the entire center area making it easier for the camera to focus on moving subjects. Nine sensors are located in the wide focus area, which are shown by the local focus area in the viewfinder. When you press the shutter-release button partway down, the camera automatically decides which sensor to be used, and the corresponding local focus area LED lights in the viewfinder.

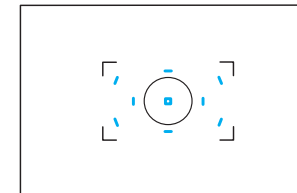

Local focus area

The local focus area mode also utilizes 9 point sensors, resulting in greater flexibility when photographing still objects. When you select any of these local focus areas, the corresponding sensor is shown in the viewfinder.

- When continuous autofocus (C) or automatic AF (A) with continuous focus is selected, the local-focus area LED will not be illuminated in the viewfinder.
- The display time of the local focus area can be selected by using Custom 14 (p. 170).

## FOCUS AREA

Choose the wide or local focus area as desired. By simply pressing the spot-AF button, the center spot-focus area is selected.

### Wide Focus Area

The camera automatically decides which sensor to be used.

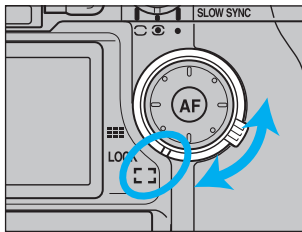
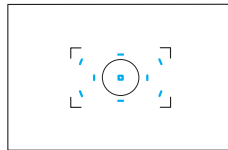

1. Set the wide/local focus-area switch to wide.

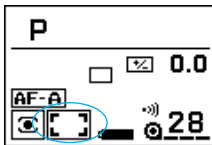

• Wide focus area appears in the display.

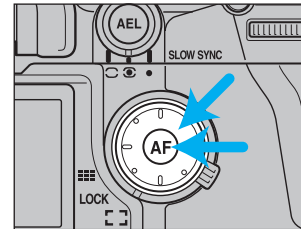

2. Press the focus-area selector to focus using the wide focus area. Press the spot-AF button to use the center spot-focus area.



- Viewfinder shows which sensor is being used for focusing.
- While pressing the spot-AF button or the focus-area selector, the focus is locked.

3. While pressing either the focus-area selector or the spot-AF button, press the shutter-release button and take the picture.

- When the exposure-mode dial is set to **P**, wide focus area is set.
- After taking the picture, as long as the spot-AF button or the focus-area selector remains pressed, focus remains locked, and additional pictures may be taken.
- If 14-segment honeycomb-pattern is selected, the exposure is locked when the focus is locked.
- When **P** is selected, autofocus is not activated by pressing the focus-area selector or the spot-AF button.

## FOCUS AREA

### Local Focus Area

Any one of the 9 local focus areas can be selected.

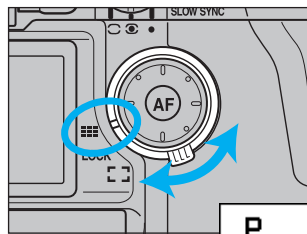
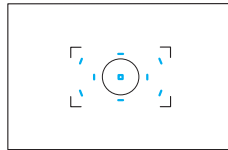

1. Set the wide/local focus-area switch to local.

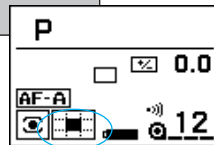

• The local focus-area appears in the navigation display.

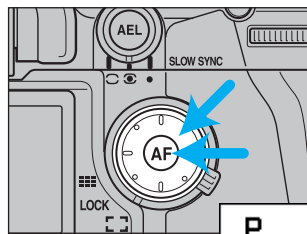

2. Press the focus-area selector to select the local focus area you want. Press the spot-AF button to use the center spot-focus area.

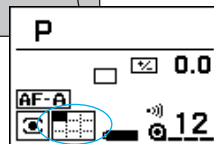

- Viewfinder shows which sensor is being used for focusing.
- While pressing the spot-AF button or the focus-area selector, the focus is locked.

3. While pressing either the focus-area selector or the spot-AF button, press the shutter-release button and take the picture.

- After taking the picture, as long as the spot-AF button or the focus-area selector remains pressed, focus remains locked, and additional pictures may be taken.
- If you release your finger from the focus-area selector or the spot-AF button, locked focus (position) is canceled, but local focus area remains.
- If 14-segment honeycomb-pattern is selected, the exposure is locked when the focus is locked.
- The same local focus area can be used to adjust focus (see p. 58).
- Only the center spot-focus area can be used with the AF Reflex 500mm f/8 lens and AF Power zoom 35-80mm, f/4-5.6.

## FOCUS AREA

### How to Lock the Local/Spot Focus Area

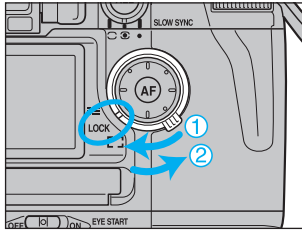

1. Turn the wide/local focus area switch to local, and select the focus area you want to lock.
2. Turn the wide/local focus-area switch to lock.

### How to Lock the Wide Focus Area

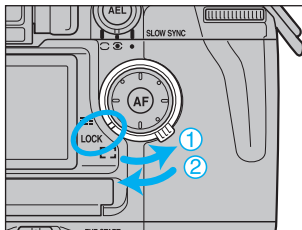

1. Turn the wide/local focus area switch to wide.
2. Turn the wide/local focus-area switch to lock.

- After taking the picture, the focus area remains locked.
- When the wide/local focus-area switch is locked, pressing the focus-area selector or the spot-AF button doesn't activate the focus.

## AF ILLUMINATOR

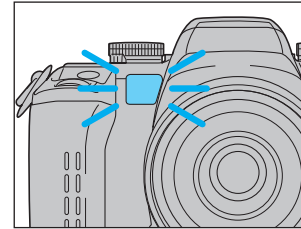

In low-light/low subject contrast situations, the AF illuminator automatically projects a pattern of lines onto the subject for the camera's AF sensors to focus on.

- Do not obstruct the AF illuminator.
- AF illuminator works for the center focus area only.
- The range of the AF illuminator is 0.7 – 7.0 meters (2.3 – 23.0 ft.).
- The AF illuminator will not fire in continuous autofocus mode.
- The AF illuminator may not operate with 300mm or longer single focal length lenses.
- The AF illuminator will not operate with 3x-1x Macro Zoom.
- When an accessory flash is attached, its AF illuminator may be active in place of the camera's AF illuminator.
- AF illuminator can be canceled by Custom 21-2 (p. 176).

# EXPOSURE

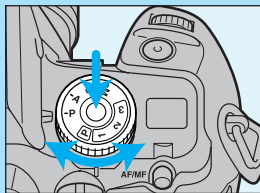

Your camera's exposure-mode dial has 8 positions:

- P** Full-auto
- P, A, S, and M modes
- 1, 2, and 3 memory modes

This section of the manual covers the P, A, S, and M modes.

- For the **P** full-auto mode, see pages 24-27. For memory modes, see page 132.

## P MODE

Select P mode (Programmed AE) when you want to give your full attention to your subject and composition. The P mode software analyzes the subject's size, motion, and magnification as well as the focal length of your lens, then sets the shutter speed and aperture according to the requirements of the scene.

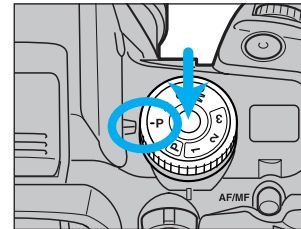

1. While pressing the exposure-mode dial lock-release button, turn the exposure-mode dial to P.
- 2 Compose your scene, focus, and take the picture.

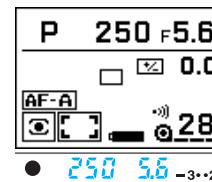

- When the shutter-release button is pressed partway down, metering occurs and the shutter speed and aperture are shown on the navigation, top data panel, and viewfinder displays.

### Comparison of **P** (full-auto) mode to P (program) mode:

In the **P** (full-auto mode), all the camera settings are set automatically.

In the P (program mode), the camera sets the shutter-speed and aperture, but all other camera settings are changeable.

## P MODE

### P-Mode Flash

When the built-in flash is up or an attached accessory flash is on, it will fire each time the shutter is released. The camera's automatic flash metering system will ensure proper exposure.

- Make sure your subject is within the flash range (p. 32).

### PA/Ps Mode

After the AE system has been activated, you can change the shutter speed or aperture selected by the camera. Creative program remains active until the display disappears.

While the aperture/shutter speed are displayed in P mode...

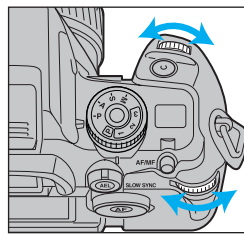

**PA 125 F8**  
Turn the front control dial to change the shutter speed.

- Aperture is adjusted automatically.

**Ps 500 F4**  
Turn the rear control dial to change the aperture.

- Shutter speed is adjusted automatically.

- The aperture and shutter speed change in 1/2 or 1/3 EV increments depending on the position of the exposure compensation dial.
- Flash can not be used with the PA and Ps modes.
  - Built-in and accessory flashes will not fire when the PA and Ps modes are active.
  - PA and Ps modes can not be selected when the built-in flash is up or the accessory flash is on.
- To cancel PA / Ps mode, press the exposure-mode dial lock-release button. It will also be cancelled 5 seconds after the display disappears, or immediately when the built-in flash is raised.

## A MODE

In A mode (aperture priority), you select the aperture and the camera automatically sets the shutter speed required for proper exposure. Set the camera to A mode when you want to control the range of focus (depth-of-field) in an image.

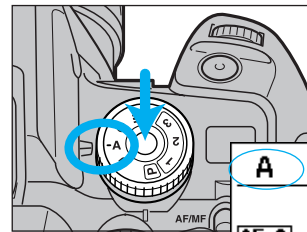

**1. While pressing the exposure-mode dial lock-release button, turn the exposure-mode dial to A.**

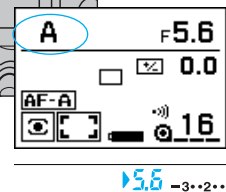

- A appears in the navigation display.
- ▶ appears in the viewfinder, next to the aperture display, indicating that the aperture can be changed.

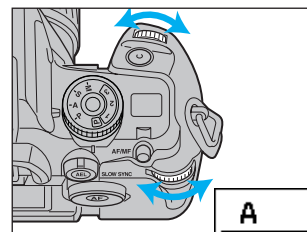

**2. Turn either control dial to select the aperture.**

- The aperture setting changes in 1/2 or 1/3 EV increments depending on the position of the exposure compensation dial. See page 77.

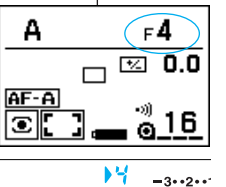

## A MODE

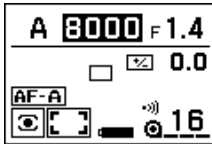

- When pressing the shutter-release button part-way down, if 8000 or 30" blinks or the printing reverses, the required setting is beyond the camera's shutter speed range. Turn the control dial until the blinking/reversing stops.

### A-Mode Flash

1. Follow the steps on the previous page.
2. Raise the built-in flash, or turn the accessory flash on.

-  appears in the viewfinder when the flash is charged.
- The shutter speed is automatically set to 1/200 or slower.
- When the built-in flash is up or an attached accessory flash is on, it will fire each time the shutter is released. The camera's automatic flash metering system will ensure proper exposure.
- The use of a large aperture is recommended for a longer flash range.

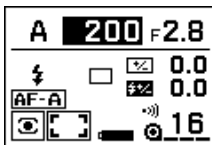

- When pressing the shutter-release button part-way down, if 200 blinks or the printing reverses, the required setting is beyond the camera's shutter speed range. Turn the control dial until the blinking/reversing stops.

### Aperture Control



Large Aperture  
(small f-number)

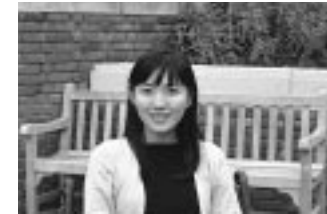

Small Aperture  
(large f-number)

The size of the aperture (lens opening) determines the depth-of-field in the final image as well as the intensity of the light falling on the film. Depth-of-field is the area in front of and behind the point where the lens is focused which will appear sharp.

Large apertures (small f-numbers) limit the depth-of-field to a narrow range. Choose a large aperture if you want a defocused background so your main subject stands out, such as with portraits.

Small apertures (large f-numbers) provide greater depth-of-field. Choose a small aperture when you want maximum focus range, such as in a landscape photograph.

- In general, wider lenses provide more depth-of-field and longer (telephoto) provide less depth-of-field.
- There is less depth-of-field when your subject is close to the lens.

## S MODE

In S mode (shutter priority), you select the shutter speed and the camera automatically sets the aperture for the proper exposure. Use S mode when you want to control the blur caused by subject movement.

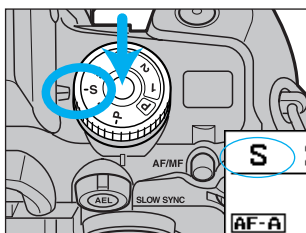

1. While pressing the exposure-mode dial lock-release button, turn the exposure-mode dial to S.

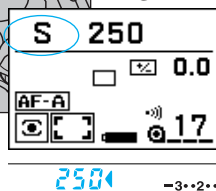

- S appears in the navigation display.
- ◀ appears in the viewfinder, next to the shutter speed, indicating that the shutter-speed can be changed.

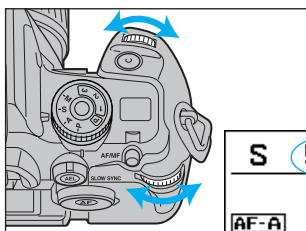

2. Turn either control dial to select the shutter speed.

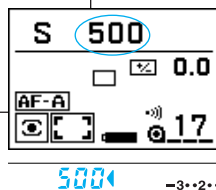

- The aperture setting changes in 1/2 or 1/3 EV increments depending on the position of the exposure compensation dial. See page 77.

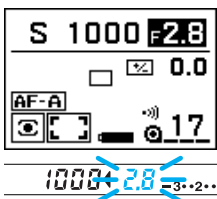

- When pressing the shutter-release button part-way down, if the aperture value blinks or the printing reverses, the required setting is beyond the camera's aperture range. Turn the control dial until the blinking/reversing stops.

- **BULB** (Time exposure) should be used when in the M mode.

### S-Mode Flash

1. Follow the steps on the previous page.  
2. Raise the built-in flash, or turn the accessory flash on.

- ⚡ appears in the viewfinder when the flash is charged.
- Shutter speeds of 1/200 or slower can be selected. However, shutter speeds greater than 1/200 can be achieved using high speed sync 5600HS(D), 3600HS(D), or 5400HS (p. 110).
- When the built-in flash is up or an attached accessory flash is on, it will fire each time the shutter is released. The camera's automatic flash metering system will ensure proper exposure.

## S MODE

### Shutter Control



Fast Shutter Speed



Slow Shutter Speed

Because the shutter speed controls the duration of exposures, it also determines how moving subjects will appear in the final image. Use a slow shutter speed to blur the motion of your subject. Use a fast shutter speed to stop the motion of your subject. In addition to stopping action, fast shutter speeds can help prevent blur caused by camera movement during the exposure.

## M MODE

M mode (Manual) gives you full control of the exposure. The camera's meter index displays how your settings compare to the exposure determined by the camera's metering system.

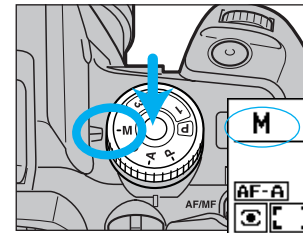

1. While pressing the exposure-mode dial lock-release button, turn the exposure-mode dial to M.

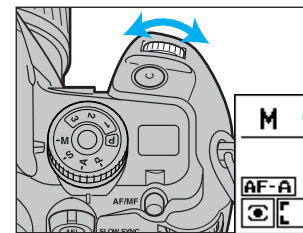
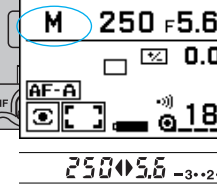

2. Turn front control dial to select the shutter speed.

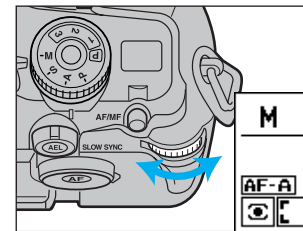
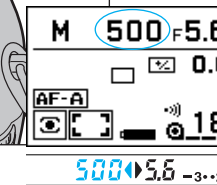

3. Turn rear control dial to select the aperture.

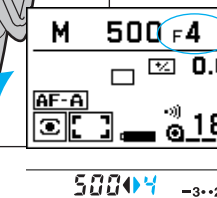

## M MODE

- ◀ ▶ appears in the viewfinder, next to the shutter-speed and aperture display, indicating that both can be changed.
- The aperture setting changes in 1/2 or 1/3 EV increments depending on the position of the exposure compensation dial.

### M-Mode Flash

1. Follow the steps on the previous page.
2. Raise the built-in flash, or turn the accessory flash on.

- ⚡ appears in the viewfinder when the flash is charged.
- The shutter speeds of 1/200 or slower are selectable. However, shutter speeds greater than 1/200 can be achieved using high speed sync flash 5600HS(D), 3600HS(D), or 5400HS (p. 110).
- When the built-in flash is up or an attached accessory flash is on, it will fire each time the shutter is released. The camera's automatic flash metering system will ensure proper exposure.

### Metering in M Mode

The meter index displays the EV difference between your settings and the 'correct' exposure determined by the camera. The 0 position (null point) represents the recommended exposure using the currently selected metering pattern (pp.82-83). (Metered manual).

—3••2••1••0••1••2••3+

Your settings match the recommended exposure.

—3••2••1••0••1••2••3+

Your settings will underexpose the metered area by 1.5EV.

—3••2••1••0••1••2••3+

Your settings will overexpose the metered area by 1EV.

—3••2••1••0••1••2••3+

Your settings will overexpose the metered area by 1.3EV.

- The EV scale is marked in 1/2 or 1/3 EV increments depending on the current setting of the exposure compensation dial (p. 77).

- ◀ or ▶ will blink in the meter index if the settings will over or underexpose the subject by more than 3.0 EV.

—3••2••1••0••1••2••3+

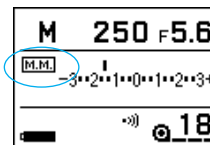

- If you press the display-selection button, the meter-index display appears in the navigation display. Index in M mode (Metered manual) is shown in the upper mid- area with **[M.M.]**.

## M MODE

### Manual Shift

Manual shift lets you shift to equivalent aperture/shutter speed combinations without changing the exposure value (EV).

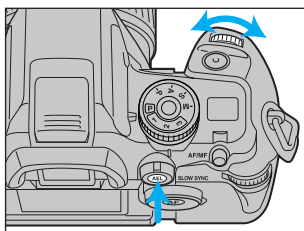

1. Select a desired shutter speed and aperture.
2. Press the AE-lock button and turn the front control dial until the desired aperture/shutter speed combination appears in the display.

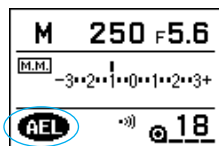

- While pressing the AE-lock button, AEL appears in the viewfinder and **AEL** appears in the navigation display.

AEL 250 F5.6 -3.

- The operation of the AE-lock button can be changed by custom function 10 (p. 168).
- When you select the 1/3 EV increments setting, the locked exposure may change if the maximum aperture of 1/2 EV increments is chosen.

# METERING

## SELECTABLE METERING

Your camera takes meter readings of the light in the scene to determine the correct exposure. It has three methods of taking meter readings. Use the method most appropriate for your subject.

### 14-Segment Honeycomb-Pattern Metering

Fourteen-segment honeycomb-pattern metering uses information from the autofocus system to set the metering pattern according to the position of the main subject. The light metered by each applicable segment is then evaluated to determine the degree of spot-lighting or backlighting present in your scene. The local focus-area (LED) momentarily displays the sensor being used when the shutter release button is pressed partway down.

Fourteen-segment honeycomb-pattern metering is the camera's standard metering mode and is appropriate for most photographic situations.

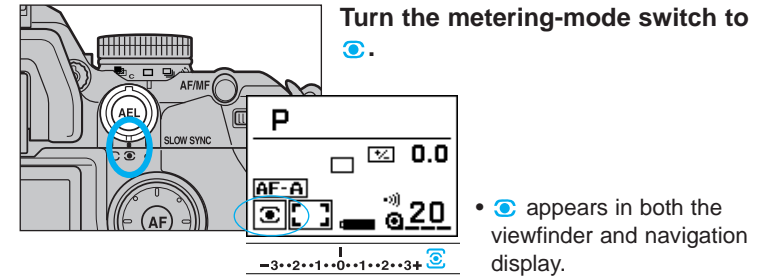
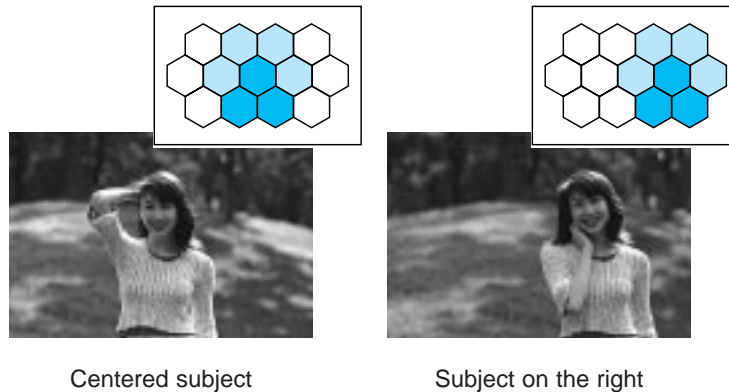

### Spot Metering

Spot metering uses only the center honeycomb segment to meter the image. The center honeycomb segment is shown by the spot metering area in the viewfinder.

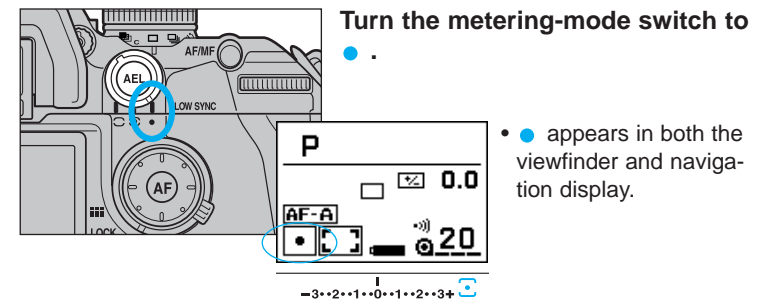
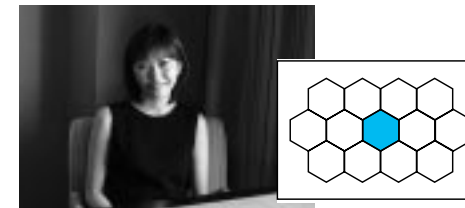



## SELECTABLE METERING

### Center-Weighted Average Metering

Center-weighted average mode bases the exposure on an average of the readings from each of the honeycomb segments - with emphasis placed on the center of the image.

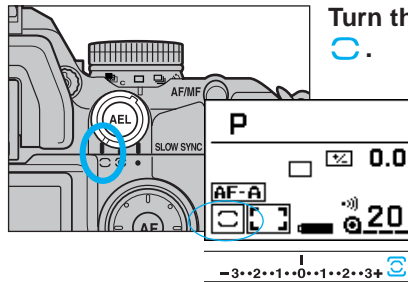
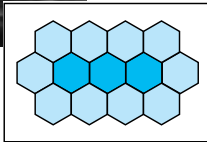
Care should be taken when photographing backlit, spotlighted, or off-center subjects, as non-subject areas may be included in the exposure calculation.



Turn the metering-mode switch to .

-  appears in both the viewfinder and navigation display.

## EXPOSURE COMPENSATION



Under exposure



Proper exposure



Over exposure

Especially helpful when using the spot or center weighted metering patterns, exposure compensation lets you manually adjust the metered exposure  $\pm 3$  EVs in  $1/2$  or  $\pm 2$  EVs in  $1/3$  EV increments. This function is especially useful when shooting with slide film, because of the film's low tolerance for exposure error.

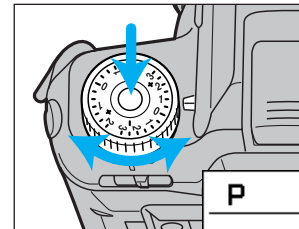

While pressing the exposure-compensation dial lock-release button, turn the exposure-compensation dial to the desired compensation value.

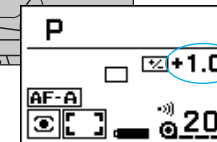

- Selected compensation value appears in the navigation display.

- Dial is locked only when you go from the 0.0 compensation setting.
- Select Custom 18 (p. 173) to change the exposure compensation value using the rear control dial in P, A, and S modes.

## EXPOSURE COMPENSATION

### Changing to 1/3 Increments

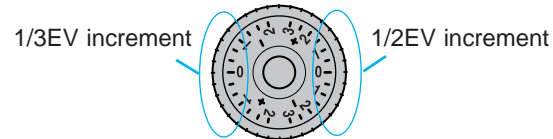

Example below shows changing from 1/2EV to 1/3EV increment.

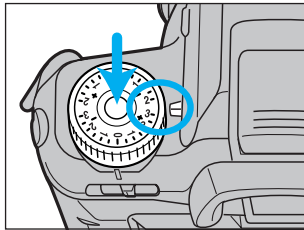

1. Set the exposure-compensation dial to the edge of the 1/2EV increment (ie; +/-3.0EV).
2. While pressing the exposure-compensation dial lock-release button, turn the exposure-compensation dial to the edge of the 1/3EV increment (ie; +/- 2.0EV).

- When going from 1/3EV increment to 1/2EV increment, use the same procedure as described in steps 1 and 2 above.
- If you select 1/3EV increment, aperture, shutter speed, and the value on the meter index will change to 1/3EV increment.
- If 1/3EV increments are selected, the lens' maximum/minimum aperture may not appear correctly, but the camera will be set correctly.

### Meter Index

The meter index displays the exposure compensation value you set.

**-3••2••1••0••1••2••3+**  
Exposure compensation  
value of -1.5  
(1/2EV increment)

**-3••2••1••0••1••2••3+**  
Exposure compensation  
value of +1.3  
(1/3EV increment)

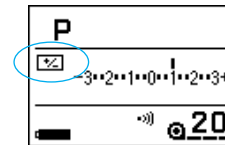

- If you press the display-selection button, the meter-index display appears in the navigation display. Exposure compensation index is shown in the upper mid-area with .

## EXPOSURE COMPENSATION

### Comparison between exposure compensation and flash compensation.

1. For exposure compensation, when the flash doesn't fire, the picture will be compensated by changes in both the shutter speed and the aperture.
  2. For exposure compensation, when the flash does fire, compensation will be due to changes in shutter speed, aperture, and the flash burst.
  3. For flash compensation, only the flash burst changes.
- Specifically for 1 and 2 above, when in;
    - P-mode - both shutter speed and aperture change.
    - A-mode - only the shutter speed changes.
    - S-mode - only the aperture changes.
  - See page 103 for additional information regarding flash compensation.
  - If you desire a fixed flash burst for exposure compensation with flash, select Custom 26-2 (p. 181).

## AUTOMATIC EXPOSURE LOCK (AEL)

Press the AE-lock button to lock the exposure using the currently selected metering pattern without locking the focus. The exposure remains locked until the AE-lock button is released.

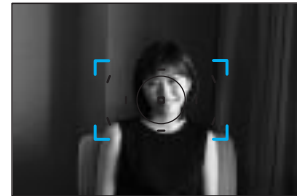

1. Select the desired metering pattern (pp. 74-76), and focus on subject.

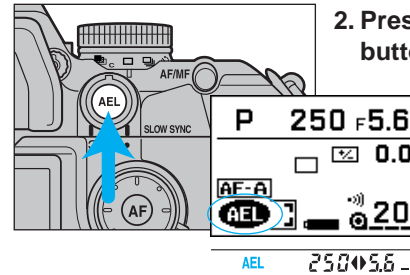

2. Press and hold the AE-lock button.

- **AEL** appears in the viewfinder and navigation display.
- Meter index also appears in the viewfinder (p. 83).

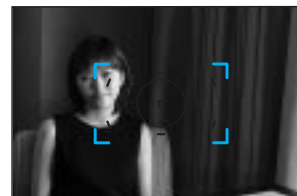

3. While pressing the AE-lock button, recompose the scene as desired.
4. While still pressing the AE-lock button, press the shutter-release button all-the-way down to take the picture.

## AUTOMATIC EXPOSURE LOCK (AEL)

- If you keep pressing the AE-lock button after taking the picture, the exposure remains locked.
- Pressing the AE-lock button sets the flash to slow-shutter sync mode (p. 102).
- If Custom 10-2 is selected, pressing the AE-lock button once activates automatic exposure lock. Pressing again cancels.

### Meter Index When AE-Lock Button is Pressed

The meter index displays the EV difference between the locked exposure and the exposure for the subject area currently inside the spot-metering area. Using the AE-lock button function, you can compare the difference between the locked (actual) exposure and the exposure in each part of the image. If the difference is more than +2.3EV, that part of the picture will be washed out. If the difference is more than -2.7EV, the picture will be dark and the details will be gone. Depending on the type of film, these values may change. Without taking the picture, you can measure the brightness and predict the results.

Example: Recompose the picture from **1** to **2**, while pressing the AE-lock button.

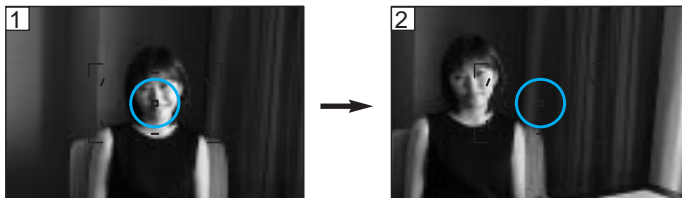

### 14-Segment Honeycomb-Pattern and Center-Weighted Average Metering

Press AE-lock button **1**. → Keep pressing AE-lock button while recomposing picture **2**.

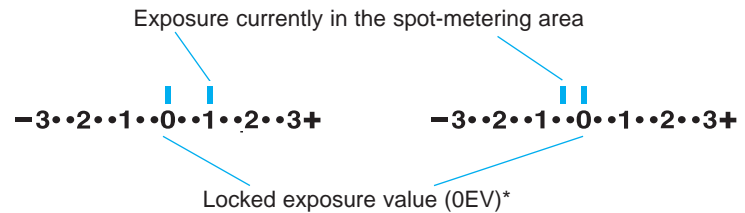

\*Locked exposure will always be 0EV unless exposure compensation is set.

### Spot Metering

Press AE-lock button **1**. → Keep pressing AE-lock button while recomposing picture **2**.

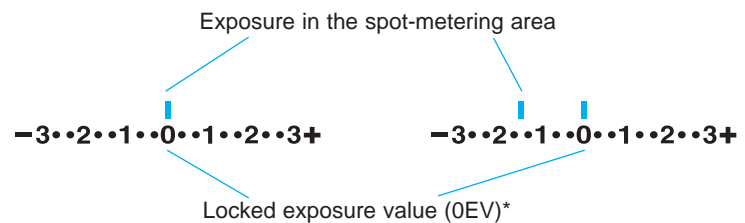

## AUTOMATIC EXPOSURE LOCK (AEL)

- The EV scale is marked in 1/2 or 1/3EV increments depending on the current setting of the exposure compensation dial (p. 77).
- ◀ or ▶ will blink in the meter index if the settings will over or underexpose the subject by more than 3.0EV.

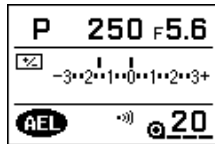

- If you press the display-selection button, the meter-index display appears in the navigation display. When you press the AE-lock button, the index shows the differences between the locked exposure and the exposure currently in the spot-metering area.

### Brightness-Distribution Display

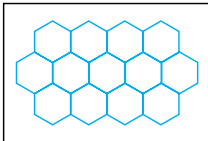

The display shows the difference between the locked value "0" and the output from each of the 14-honeycomb segments.

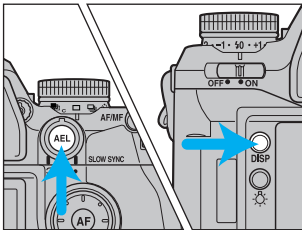

**While pressing the AE-lock button, press the display-selection button. Each segment will be shaded and a value indicated.**

- The shading appears as;
  - White : +1EV or more.
  - Gray : when between -1EV and +1EV. (No value given when gray)
  - Black : -1EV or less.

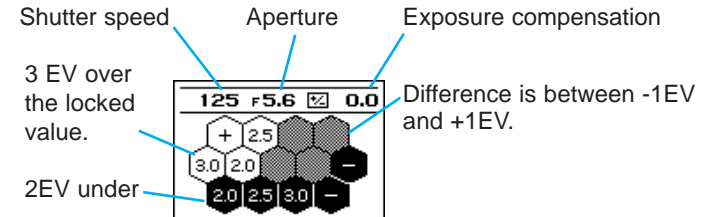

- If more than 3.0EV, only + or - will appear, instead of a value.
- Press the display-selection button once again to cancel the brightness-distribution display while still pressing the AE-lock button.
- If you release your finger from the AE-lock button, both brightness distribution and locked exposure will be canceled.
- Shutter speed, aperture, and exposure compensation appear in the top portion of the display.
- If a non-displayed setting is changed, the operation display appears.
- This feature is useful for monitoring which areas of the picture are under or over-exposed, and allows the user to also confirm the variation on the brightness distribution with the exposure-compensation dial.
- If bracketing is selected, the normal position (+/- 0) of the bracketing series will be displayed in the brightness-distribution display.
- Brightness-distribution display shows values without flash. When flash fires, displayed values may be slightly lower than the values without flash.
- The EV scale is marked in 1/2 or 1/3EV increments depending on the current setting of the exposure compensation dial (p. 77-78).

## SETTING THE ISO MANUALLY

Set the ISO manually to override the DX-coded ISO or when using non-DX coded film.

- Film must be loaded before the ISO can be changed.
- Non-DX coded film is initially set to the previous roll's ISO.

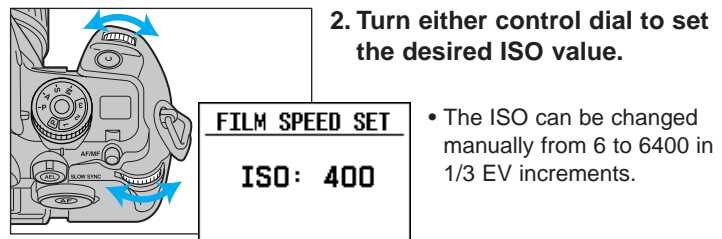
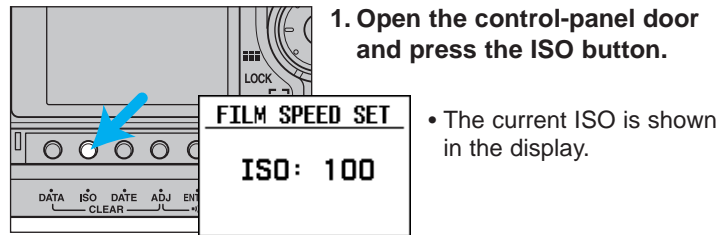



**3. Press the shutter-release button partway down to enter the new ISO.**

Custom 4-2 DX Memory ON (p. 164).  
Applies ISO changes to future rolls with the same DX-coded ISO.



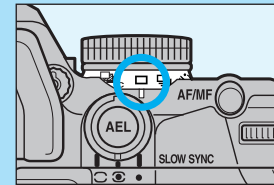

## DRIVE

Continuous drive, exposure bracketing, multiple exposures, and other options can be selected using the drive-mode lever.



The standard drive-mode setting for this camera is single-frame (drive-mode lever set to ).

The selectable modes are represented by;

-  (Single-frame advance)
-  (Continuous advance)
-  Bracketing
  - S (Single frame advance)
  - C (Continuous advance)
-  Self-timer
-  Multiple Exposure

- The drive-mode lever can not be changed while pressing the exposure-mode dial lock-release button.

## CONTINUOUS

This camera has both single-frame and continuous advance drive modes. Select single-frame advance to expose and advance the film one frame at a time. Switch to continuous drive to photograph dynamic action sequences at up to 4 frames per second in high speed mode (3.7 when AF-A or AF-C is selected) or 2 frames per second in low speed mode.

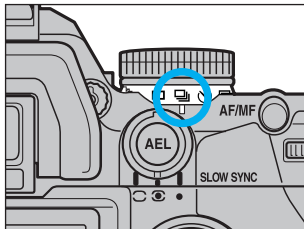

1. Turn the drive-mode lever to the desired drive mode.

-  - Single-Frame Advance
-  - Continuous Advance

If continuous advance is selected...

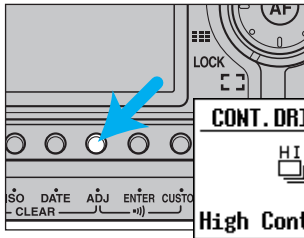

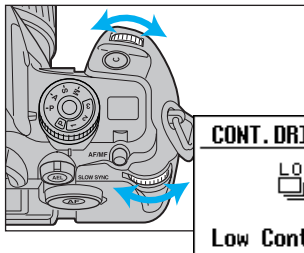

2. Open the control-panel door, then press the adjust button.

- The display will switch to the setting display.

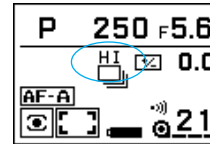

3. Turn either control dial to select high or low speed continuous drive.



- Press the shutter-release button partway down to enter the setting.  HI remains for high continuous,  LO remains for low continuous mode.

4. Keep pressing the shutter-release button to take the pictures.

- The high or low setting will remain selected until you change it.
- When the built-in flash is up or an accessory flash is on, the shutter can not be released until the flash is charged.
- The shutter can not be released until the camera has focused on your subject.
- If AF-S (Single-shot autofocus) is selected, focus will be locked until the series of continuous frames is finished.
- Return the drive-mode lever to  to cancel the continuous drive mode.
- AF Zoom xi and Power zoom lenses cannot be zoomed when continuous-advance mode is selected.
- When the battery power is low or in low temperatures, the maximum drive speed may temporarily drop. Continued operation with low battery power may even cause a complete stoppage.

DRIVE

## SELF-TIMER

Use the self-timer to delay the shutter release for 2 or 10 seconds (approx.) after the shutter-release button is pressed all the way down. In addition to delaying release of the shutter, the 2 second delay pops the mirror up two seconds before the shutter opens to reduce blur caused by camera vibration.

- Attach the eyepiece cap (p.127) when there is a bright light source behind the camera.

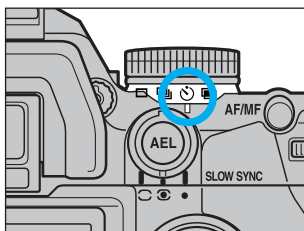

1. Place the camera on a tripod, then turn the drive-mode lever to .

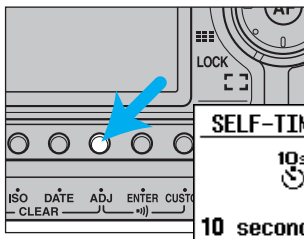

2. Open the control panel door and press the adjust button.



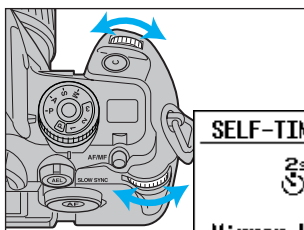

- Self-timer set display appears.

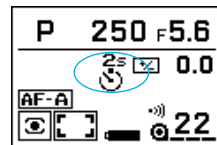
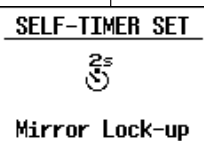

3. Turn either control dial until the desired delay appears in navigation display.



- Press the shutter-release button partway down to enter the setting.  2s remains for 2 second delay,  10s remains for 10 second delay.

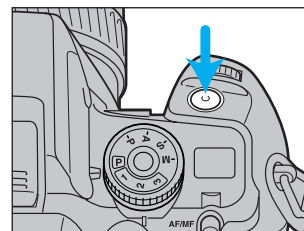

4. Center your subject in the focus frame, then press the shutter-release button partway down to confirm the focus.

5. Press the shutter-release button all the way down to start the timer.

- 10 seconds (10 s) –The self-timer lamp on the front of the camera will blink slowly, then blink rapidly just before the shutter releases.
- An audio sound will also be heard for the 10 second self-timer. It can be canceled if desired (p. 131).
- Turn the camera off or select another drive mode to cancel the 10 second self-timer.
- 2 seconds (2 s) –The mirror pops up when the shutter-release button is pressed all-the-way down. The shutter is released two seconds later.
- The 2 second self-timer cannot be cancelled.
- The red-eye reduction flash mode is not effective when the 2 second self-timer is selected.

## EXPOSURE BRACKETING

Exposure bracketing automatically exposes a series of frames with exposures above and below the metered exposure value. Bracket your exposures when shooting slides and other films with a low tolerance for exposure error. A larger bracketing increment is recommended when shooting negative film.

- This camera can expose a 3, 5, or 7 frame brackets in increments of 0.3, 0.5, 0.7, or 1.0 EV.

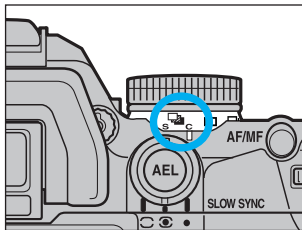

1. Turn the drive-mode lever to the desired bracketing mode.
  - ☐ S - Single Frame Advance
  - ☐ C - Continuous Advance

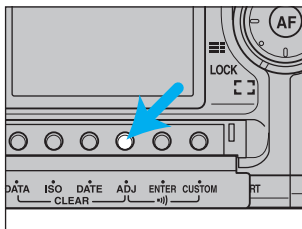

2. Open the control-panel door, then press the adjust button.
  - The current bracketing increment and size of the bracket is shown in the display.

Exposure-bracketing indicator

Front-control-dial indicator

Rear-control-dial indicator

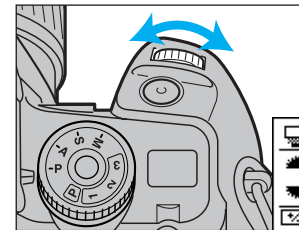
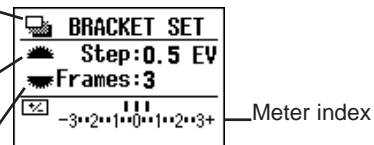

3. Turn the front control dial to set the bracketing increment (0.3, 0.5, 0.7, 1.0 EV).

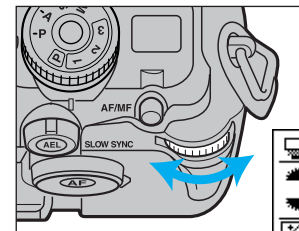
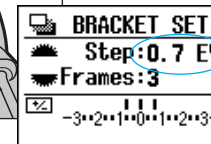

4. Turn the rear control dial to set the size of the bracket (3, 5 or 7 frames).

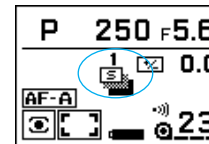
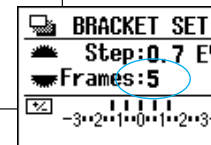

- Press the shutter-release button partway down to enter the setting. remains for single frame advance, remains for continuous frame advance mode.

5. Compose (and meter) your subject, then press the shutter-release button all the way down to start the bracketing.

- In S - Single-frame advance, press the shutter-release button for each exposure.
- In C - Continuous advance, hold the shutter-release button until the series is finished.

DRIVE

## EXPOSURE BRACKETING

- To cancel, move the drive-mode lever to a different mode.
- The normal sequence (for a 5 frame bracket in 1/2 increments) is;
 

**Normal** → -0.5EV → +0.5EV → -1.0EV → +1.0EV

 However by selecting Custom 11-2, the following sequence is possible; (p 169.)
 

-1.0EV → -0.5EV → **Normal** → +0.5EV → +1.0EV
- Exposure is locked on the first frame of the series.
- P mode (programmed autoexposure) exposures are bracketed by changing both the aperture and shutter speed.
- S (shutter priority) mode and Ps mode exposures are bracketed by changing the aperture.
- M mode (manual), A mode (aperture priority) and PA mode exposures are bracketed by changing the shutter speed.
- Press the AE-lock button when the shutter is released to bracket using the aperture in manual (M) mode.

### Single Frame Advance

- The number above the bracket indicator in the display and also in the viewfinder, increases each time you take a picture.
- Film can be changed in the middle of the bracketed series.
- Turn the camera off, or select another drive mode to cancel single frame advance bracketing.

### Continuous Advance

- Removing your finger from the shutter-release button before the series is complete resets the camera to the first frame of the bracket.
- Continuous advance bracketing is cancelled at the end of the roll.

## Meter Index

When bracketing is selected, the meter index appears in the viewfinder.

- If exposure compensation is also selected, the whole bracketing series will be shifted.
- Meter index doesn't appear in the viewfinder while adjusting the increment and size of the bracketing.
- Every time the picture is taken, the corresponding bar will disappear.

-3••2••1••0••1••2••3+

Bracketing increment - 0.7EV  
Size of bracket - 3 frames

-3••2••1••0••1••2••3+

Bracketing increment - 0.5EV  
Size of bracket - 5 frames  
Exposure compensation - +1.0EV

- If a 1/2EV exposure increment is selected with a 0.3 or 0.7EV exposure bracketing increment, or if a 1/3EV exposure increment is selected with a 0.5EV exposure bracketing increment, then the position of the bar in the meter index shown in the viewfinder will be slightly shifted. However, the exposure will be exactly as set.

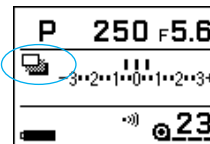

- If you press the display-selection button, the meter-index display appears in the navigation display. Exposure bracketing index is shown in the upper mid-area with .

With the exposure history display, the next exposure value is reversed printed to tell you that camera setting is different.

23		3.5	0.0
22	125	3.5	+0.5
21	200	3.5	0.0
20	250	3.5	-0.5
19	350	3.5	-1.0
18	90	8	0.0

Dial setting only. The actual bracketing value may not be as indicated in the reverse printed area.

Actual exposure values for the previous 5 exposures.

## MULTIPLE EXPOSURE



The multiple exposure function makes it possible to expose 2 or more images on the same frame.

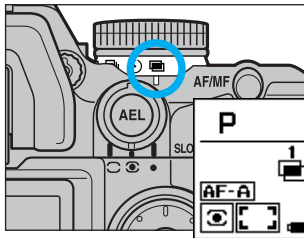

1. Turn the drive-mode lever to .

• **M1** appears in the display's frame counter.

2. Compose the scene, then press the shutter-release button all the way down to take the first exposure.

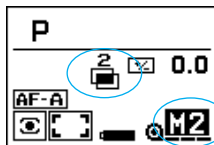

- After the first exposure, **M2** appears in the display and is reverse printed telling you that the next exposure will be overlapped.
- Take additional exposures as desired.
- Additional exposures are counted only up to **M9**, but an unlimited number of exposures can be taken.
- The number on the  also increases up to 9.

3. Select another drive mode to cancel multiple exposure mode and to advance the film to the next frame.

The meter in your camera determines exposure (EV) based on the assumption that only one exposure will be made on each frame. When making multiple exposures, the EV for each additional exposure may need to be reduced or over exposure can result.

Compensate the exposures as follows:

Number of Exposures	1	2	3	4	6	8
Exposure Adjustment	0	-1	-1 1/2	-2	-2 1/2	-3

- The above corrections are intended as a general guideline. Some testing may be necessary to produce the desired results.
- Compensation may not be necessary if all of the exposures have dark backgrounds and the subjects of the exposures will not overlap.
- Exposure can be compensated in 1/2 or 1/3 EV increments using the exposure compensation function (p. 77).
- The camera can be turned off and back on during a multiple exposure series.
- When date/time imprinting is selected, the date/time will be printed when the film is wound.
- When using negative film, tell your photofinisher there are multiple exposures on the roll. Some photofinishers may not automatically print multiple exposure.
- If Custom 3-2 is selected, you can partially rewind the film and overlap an exposure on a previously exposed frame (p. 161-163).

# FLASH

This section of your manual covers the operation of accessory flashes as well as the built-in flash.

The high accuracy of your camera's flash metering is realized by ADI (Advanced Distance Integration) flash metering in combination with the newly developed D flash units and D lenses. Flash metering is controlled by the guide number in addition to pre-flash metering. Compared with the conventional TTL flash metering, flash output is less influenced by the background conditions or the subject's reflectance in ADI flash metering, offering optimum flash metering.

Your camera's built-in flash provides coverage for a 24mm angle of view, with a flash guide number of 12.



ADI flash metering



Conventional TTL metering

## FLASH MODE SWITCH

Flash pictures can be taken using the built-in flash or with separately sold accessory flash units.

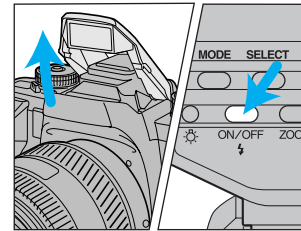

**Built-in flash - Raise the built-in flash.**

**Accessory flash - Turn the accessory flash on.**

- In **[P]** full-auto mode, the flash will automatically fire when necessary. **PLUTO** will appear in the navigation display.
- When you are not in **[P]** full-auto mode, the flash will fire every time. **⚡** will appear in the navigation display.

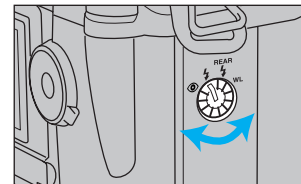

- The flash-mode switch has four positions.

	Built-in flash	Program Flash
	Red-eye reduction (p. 100)	Normal flash
	Normal flash (p. 31)	Normal flash
<b>REAR</b>	Rear flash sync (p. 101)	Rear flash sync (p. 101)
<b>WL</b>	Wireless/remote flash (p.112)*	Normal flash

\* If you use the built-in flash with the flash-mode switch set to WL, the exposure will not be correct.

## RED-EYE REDUCTION

When photographing people or animals at night or in other low-light situations, the effect called red-eye may occur due to the flash reflecting off the inside of the subject's eyes. To reduce this effect, the flash fires a series of small bursts before the main flash burst. This causes the subject's pupils to close, greatly reducing the amount of light which will reflect off the retina.

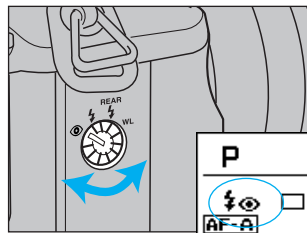

1. Raise the built-in flash and turn the flash-mode switch to .

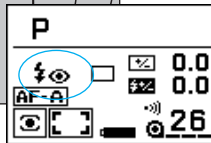

•  appears in the navigation display.

2. Press the shutter-release button to take the picture.

- Warn your subject that the flash will fire a few short bursts just before the picture is taken.
- Red-eye reduction can only be used with the built-in flash.
- Red-eye reduction is not effective when used with self-timer, mirror lock-up function (p. 90).

## REAR FLASH SYNC



With rear flash sync



Without rear flash sync

Slow sync flash exposures can appear unnatural because the motion blur precedes the subject in the final image. Use rear flash sync to create more natural looking slow shutter speed flash exposures that leave a blur of motion behind the subject.

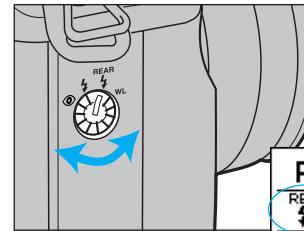

1. Raise the built-in flash, or turn the accessory flash on, and turn the flash-mode switch to REAR .



•  appears in the display.

2. Press the shutter-release button to take the picture.

- Flash synchronization returns to front sync (standard operation) when shutter speeds faster than 1/60 are selected.
- Rear flash sync cannot be used with red-eye reduction or wireless flash.

## SLOW-SHUTTER SYNC



Slow-shutter sync



Conventional flash

In P and A-modes, slow-shutter sync sets a slower shutter speed to increase the background or ambient exposure in a flash picture. Flash output is automatically decreased to maintain correct subject exposure.

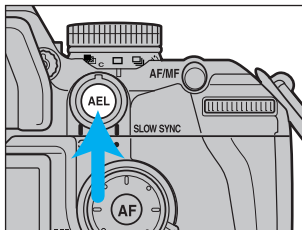

1. Raise the built-in flash or turn the accessory flash on.
2. While pressing the AE-lock button, press the shutter-release button all the way down to take the picture.

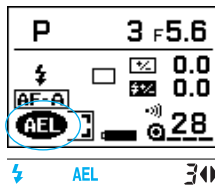

- AEL and the locked exposure will be displayed in the display and the viewfinder.
- The shutter speed may not be reduced if the background is bright or a large aperture is set (A-mode).
- Use a tripod if the shutter speed becomes too slow to allow sharp, hand-held pictures.
- Custom 10-2 lets you press the AE-lock button once to activate slow-shutter sync. Press again to cancel (p. 168).

## FLASH COMPENSATION

Use flash compensation to increase or decrease the output of the built-in or an attached accessory flash up to  $\pm 2$  EV in 1/2EV increments. This function is especially useful when shooting with slide film, because of the film's low tolerance for exposure error.

Flash compensation changes the flash exposure by the amount set relative to the ambient exposure.

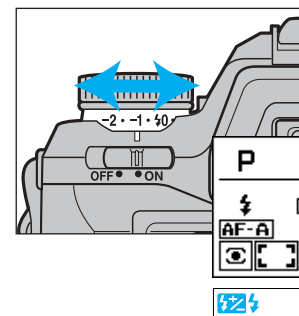

Rotate the flash-compensation dial to the desired compensation value.

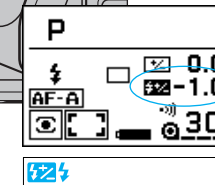

- Selected compensation values appear in the navigation display.
- $\pm$  appears in the viewfinder.

- Flash compensation does not modify the output of a flash set to manual flash or connected to the PC terminal.
- Flash compensation has no effect on the ambient light exposure.
- Flash compensation and exposure compensation can be used together. See page 80 for their comparison.
- Over exposure, using flash compensation, may not be possible with the built-in flash.

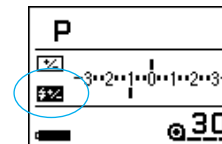

- If you press the display-selection button, the meter-index display appears in the navigation display. The flash compensation index is shown in the lower mid-area with  $\pm$ .

## FLASH BRACKETING

Flash bracketing lets you expose a series of frames with exposures below and above the normal metered exposure while using flash. You can choose a series of 3, 5, or 7 frame flash exposure brackets in 0.3, 0.5, 0.7, or 1.0 EV increments. Exposures are bracketed by controlling the flash output.

- A larger bracketing increment is recommended when shooting negative film.

### 1. Raise the built-in flash or turn the accessory flash on.

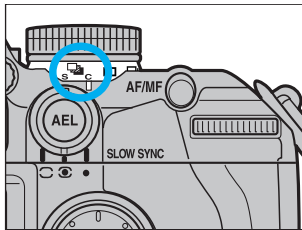

### 2. Turn the drive-mode lever to single-frame advance (S) or continuous-frame advance (C) bracketing mode.

- The shutter-release button must be pressed for each exposure, even when the lever is in the (C) position.

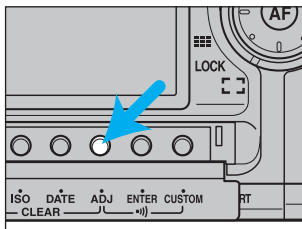

### 3. Open the control-panel door, then press the adjust button.

- The set display appears in the navigation display.

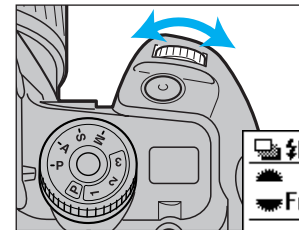
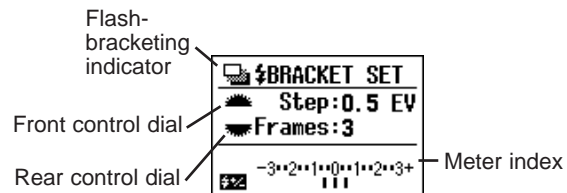

### 4. Turn the front control dial to set the bracketing increment (0.3, 0.5, 0.7, 1.0 EV).

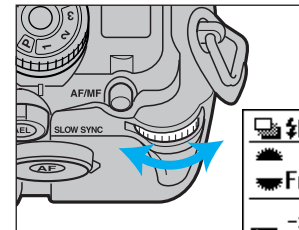
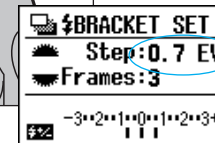

### 5. Turn the rear control dial to set the size of the bracket (3, 5 or 7 frames).

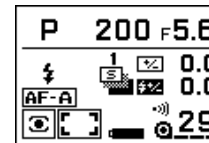
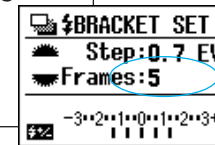

- Press the shutter-release button partway down to enter the settings. or remains in the display while flash bracketing is set.

### 6. Compose your subject and press the shutter-release button all the-way-down to take the picture.

### 7. Repeat step 6 until the series is complete.

- Turn the camera off, change the drive mode, push the built-in flash down to cancel the bracketed series.

## FLASH BRACKETING

- The normal sequence (for a 5 frame bracket in 1/2 increments) is;

**Normal** → **-0.5EV** → **+0.5EV** → **-1.0EV** → **+1.0EV**

However by selecting Custom 11-2, the following sequence is possible; (p 169.)

**-1.0EV** → **-0.5EV** → **Normal** → **+0.5EV** → **+1.0EV**

- The number above the bracket indicator in the display and also in the viewfinder, increases each time you take a picture.
- Film can be changed in the middle of the bracketed series.
- Bracketing towards overexposure may not be possible with the built-in flash.

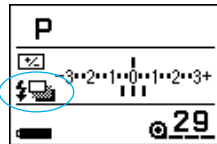

- If you press the display-selection button, the meter-index display appears in the navigation display. The flash bracketing index is shown in the lower mid-area with .

## ACCESSORY FLASH

By using an optional accessory flash, such as the 5600HS(D), you can get improved flash performance over the built-in flash. The accessory flash units fit in the shoe located on the top of your camera.

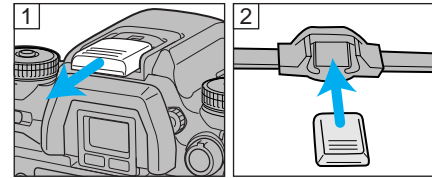

- Your camera comes with an accessory shoe cap which protects the accessory shoe contacts. When using a flash or other accessory, remove the accessory shoe cap (1) and store the shoe cap into the eyepiece cap for safekeeping (2).

- The flash signals for the accessory flash are the same as those for the built-in flash (p. 31).
- Refer to the specific instruction manual for each accessory flash to obtain the flash range. For the 5600HS(D), 5400HS, and 5400xi, the flash range will also appear in their data panels.

FLASH

## FLASH METERING

Flash metering changes according to the flash unit and lens being used.

	D lens	Other lenses
5600HS(D) 3600HS(D)	ADI metering (HSS on, with pre-flash)	Pre-flash metering (HSS on)
5400HS	Pre-flash metering (HSS on)	Pre-flash metering (HSS on)
Other accessory flashes	TTL metering	TTL metering
Built-in flash	ADI metering (without pre-flash)	TTL metering

- When the shutter speed is faster than 1/200 sec, flash metering will be HSS-TTL. If Wireless/Remote flash is set, metering will be Wireless/Remote-TTL.

### TTL metering (Through-the-lens):



The TTL flash metering system determines the flash exposure automatically.

### Pre-flash metering:

A pre-flash fires before the main exposure. The preflash is metered (14 segment) and fed back to the flash exposure system to more accurately determine the flash exposure.

### ADI metering (Advanced Distance Integration):

Flash metering is controlled by the guide number in addition to TTL metering. Flash output is less influenced by the background conditions or the subjects reflectance.



When using an accessory flash with HSS function, and if HSS is turned on, then pre-flash fires and ADI/Pre-flash metering will occur (blue area of the chart ). When using a D lens, ADI metering is also done using the built-in flash ( area).

- TTL 4-segment flash metering will be used instead of ADI/Pre-flash metering, when HSS is off, bounce flash is set, or when an off-camera cable is used to connect multiple flash units. TTL average metering will be used instead of ADI/Pre-flash metering when rear flash or the mirror lock-up function is selected.

### Use of a Flash/Color Meter with Pre-Flash

When pre-flash fires, a flash/color meter cannot meter accurately. This is because the purpose of pre-flash is to assist ADI/Pre-flash-metering, not to provide illumination for the picture. Cancel HSS (see flash manual) or eliminate the influence on metering using Custom 20-2/3 (p. 175). Those items affected are in  in the chart on page 108. However, if you use the test-flash button on the flash, the pre-flash will not fire.

### When Using a Close-up Diffuser, Certain Filters and Lenses

When close-up diffuser CD-1000, or a filter whose stop's increase is not 0 (i.e., ND) is used, or when the focus-range limiter or macro release of certain lenses are used, the proper exposure will not be obtained by ADI or Pre-flash metering. For those items in  (p. 108), cancel the HSS or choose Custom 20-2/3. When using the built-in flash , you must choose Custom 20-2/3 .

- Custom 20 gives you the choice of (1) ADI 4-segment flash metering, (2) TTL 4-segment flash metering, (3) TTL average flash metering (p. 175).

## HIGH-SPEED SYNC



High-speed sync



Conventional-fill flash

The maximum sync speed for this camera is 1/200. However, with the 5600HS(D), 5400HS, and 3600HS(D) accessory flashes (sold separately) shutter speeds up to 1/8000 can be used. High-speed sync (HSS) allows faster shutter speeds when fill flash is used on moving subjects outdoors. HSS also lets you use large aperture/high shutter-speed combinations to separate your subject from the background by limiting the depth-of-field.

**Attach the 5600HS(D), 5400HS or 3600HS(D) and set it to HSS mode.**

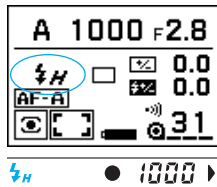

- **H** automatically appears in the viewfinder and the navigation display at shutter speeds faster than 1/200 sec when the 5600HS(D), 5400HS, or 3600HS(D) is attached.

- When using flash and color meters, high-speed sync is not possible. Turn the flash's HSS off or use a shutter speed of 1/200 second or slower.
- Shutter speeds faster than 1/200 second are not available when the 2 second self-timer or rear flash sync has been selected.

## WIRELESS/REMOTE OFF-CAMERA FLASH



Normal Flash

Wireless/Remote Flash is available with the Minolta 5600HS(D), 5400HS, 3600HS(D), 5400xi, and 3500xi accessory flashes. Wireless/Remote flash lets you experience the creative control available with an accessory flash.

In Wireless/Remote flash mode, the off-camera flash is triggered by a coded signal from the camera's built-in flash when you press the shutter-release button. When proper exposure has been received, another signal cuts the accessory flash off.

You can also achieve a 2:1 lighting ratio automatically. When remote ratio flash is selected, the off-camera flash provides 2/3 of the full exposure while the built-in flash provides the remaining 1/3.



Wireless/Remote Flash



Wireless/Remote Ratio Flash

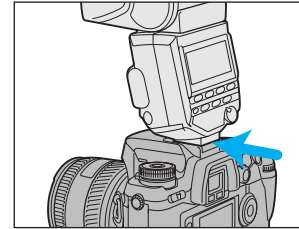

1. Attach the accessory flash to the camera, then turn the camera and the flash on.

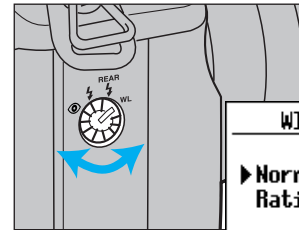

2. Turn the flash-mode switch to WL.

WIRELESS

▶ Normal  
Ratio 2:1

- The wireless set display appears in the navigation display.

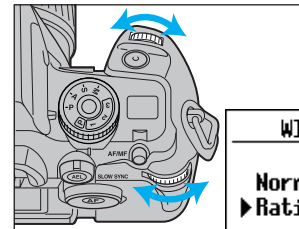

3. Turn either control dial and select normal wireless or ratio.

WIRELESS

▶ Normal  
Ratio 2:1

- Normal Wireless : When selected, only the accessory flash fires.
- Ratio: When selected, the built-in flash will provide 1/3 and the accessory flash will provide 2/3 of the total exposure.

## WIRELESS/REMOTE OFF-CAMERA FLASH

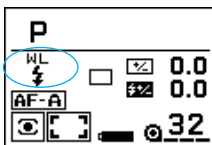

### 4. Press the shutter-release button partway down.

- Navigation display returns to the previous display.
- WL appears in the display.

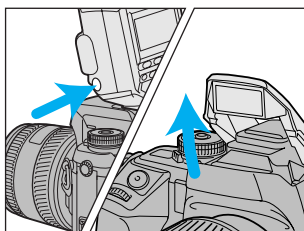

### 5. Detach the accessory flash, then raise the built-in flash.



- WL appears in the viewfinder.

### 6. Position your camera and flash unit using the information on this page.

- Wireless/Remote flash is most effective when used in dark or poorly lighted areas.
- Refer to your flash instruction manual for more detailed flash to subject distance information.

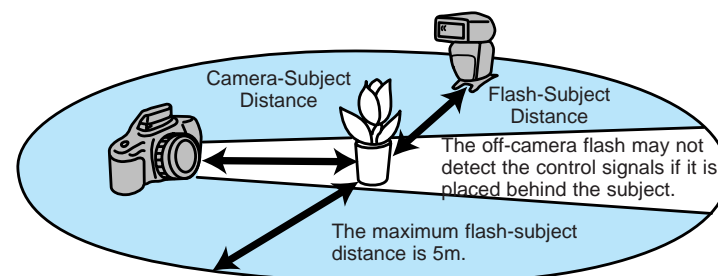

FLASH

	Camera - subject	Flash - subject			
		Non HSS		HSS	
Shutter speed	All shutter speeds	- 1/60	1/60 - 1/200	1/250	1/1000
Aperture					
2.8	1.4 - 5m 4.6 - 16 ft.	1.4 - 5 m 4.6 - 16 ft.	1 - 5 m 3.3 - 16 ft.	1 - 5 m 3.3 - 16 ft.	1 - 2.5 m 3.3 - 8 ft.
4	1 - 5m 3.3 - 16 ft.	1 - 5 m 3.3 - 16 ft.	1 - 5 m 3.3 - 16 ft.	1 - 3.5m 3.3 - 11.5 ft.	1 - 1.7m 3.3 - 5.5 ft.
5.6	1 - 5m 3.3 - 16 ft.	1 - 5 m 3.3 - 16 ft.	1 - 5 m 3.3 - 16 ft.	1 - 2.5m 3.3 - 8 ft.	1 - 1.2 m 3.3 - 3.9 ft.

- The table above is for ISO 100 film. Distance will be double if you are using ISO 400 film (maximum 5m/16 ft).
- HSS is possible only with D flash.

## WIRELESS/REMOTE OFF-CAMERA FLASH

WL

-3-2-1-

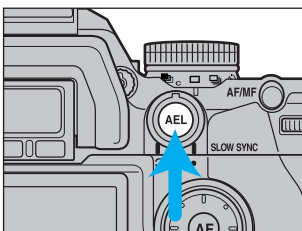
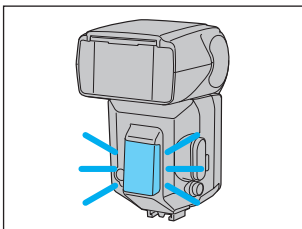

### 7. Wait until both flash units are fully charged.

- appears in the viewfinder when the built-in flash is charged.
- When the off-camera flash is charged, its AF illuminator will blink.

### 8. Press the AE-lock button to test fire the accessory flash.

- Caution; Test firing the flash will activate slow-shutter sync (p. 102) if Custom 10-2 (p. 168) is selected. Custom setting 10-1 is recommended.
- If unsuccessful, change the position of the camera or the flash.

### 9. Press the shutter-release button all the way down to take the picture.

- There is no limit for shutter speed when using 5600HS(D)/3600HS(D) in normal wireless, as these have high-speed sync capability in wireless/remote off camera flash mode. However, in wireless ratio mode or when using 5400HS, 5400xi, or 3500xi in wireless/remote flash mode, the shutter speed should be 1/60 second or slower.

### Switching Between Normal WL Flash and Ratio WL Flash

1. Turn flash-mode switch to a position other than WL and then back to WL.
2. The wireless set display appears in the navigation display. Select normal or ratio-flash by turning either the front or rear control dial.

### Canceling the Wireless/Remote Flash

1. Attach the accessory flash to the camera, and turn both the camera and flash on.
2. Turn the flash-mode switch to a position other than WL.

### Wireless/Remote Flash Using more than one flash

Wireless/remote flash with two or more accessory flashes is also possible. If you use both a D series flash and a non-D series flash, attach a non-D flash to the camera and set wireless mode. Otherwise, the non-D flash doesn't fire.

### Additional Wireless/Remote Flash Options

In addition to the procedure described on p. 112-116, where the built-in flash acts as the controller, there are two other ways in which wireless/remote flash can be used;

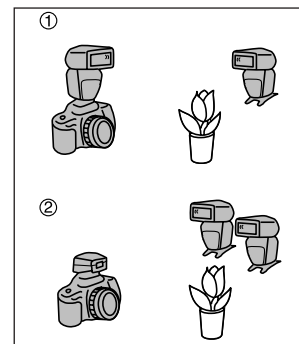

- ① Using 2 accessory flashes with one (5600HS(D), 5400HS, or 5400xi) attached to the camera acting as the controller, the other accessory flash acting as an off-camera flash.
- ② Using a Wireless/Remote Flash Controller as the controller, and one or more accessory flash as an off-camera flash.

## PC TERMINAL

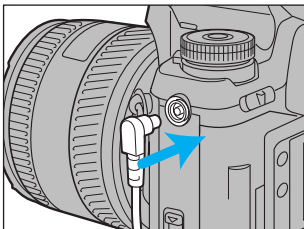

Flash units which can not be connected to the accessory shoe can be connected to the camera via the PC terminal.

- Set the exposure mode dial to M.
- Set the shutter speed to 1/200 or slower.

- The flash unit may fire unexpectedly if it is on when the sync. cord is plugged into the PC terminal.
- TTL flash metering does not function when the flash is connected to the PC terminal.
- Flash compensation is not possible. However, flash bracketing is possible if you press the AE-lock button while taking a picture.
- The PC terminal is compatible with both center positive (normal polarity) and center negative (positive polarity) flash units.
- When using the PC terminal, rear flash sync can not be used.

## ADDITIONAL FEATURES

## DATE/TIME IMPRINTING

The Quartz-data function lets you record the date or time onto the lower left-hand corner of the photograph. The automatic calendar is good through the year 2039.



Approximate location of print area.

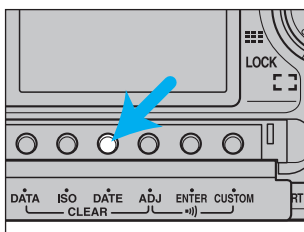

1. Open the control-panel door and press the DATE button.

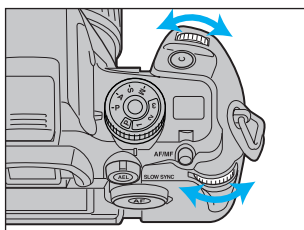

2. Turn the front or rear control dial to select the date you want.

• The display changes as follows;

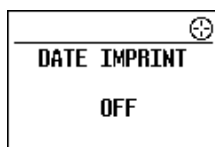

No printing

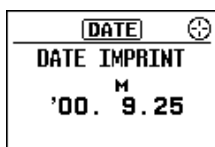

Date printing

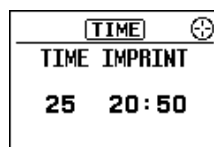

Time printing

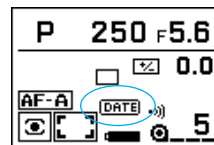

- When you press the shutter-release button partway down, the display returns to the previous display.
- If the printing option is selected, **DATE** or **TIME** remains in the navigation display.
- “M” appears over the month.

- Imprinted data may be difficult to read if the lower left area of the photograph is bright or non-uniform.
- Printing intensity can be changed using Custom 33 (p. 186).
- Imprinting may not be done or it may be overlapped on the last frame of a roll.
- The sequence of the date off, date on, and time imprint displays can also be controlled using the focus-area selector.

### Setting the Date/Time

- If the camera batteries are removed for a long period of time, the date/time may have to be reset.

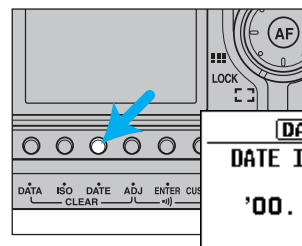

1. Open the control-panel door and press the DATE button.

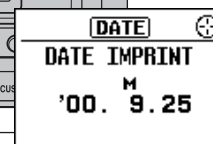

- The date imprint window appears in the navigation display.

## DATE/TIME IMPRINTING

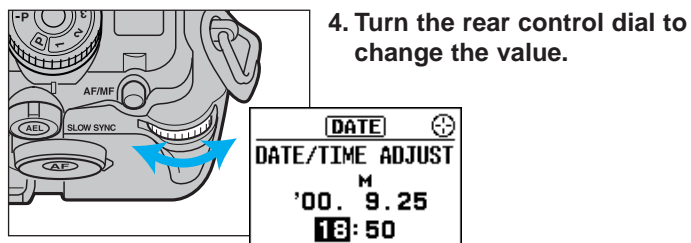
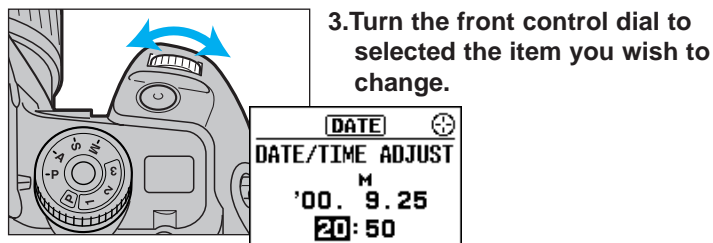
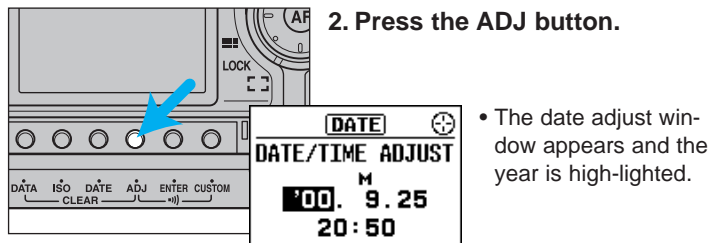

- Repeat steps 3 and 4 until the correct date/time is set.
- After all items are set, press the shutter-release button partway down. The normal display returns.

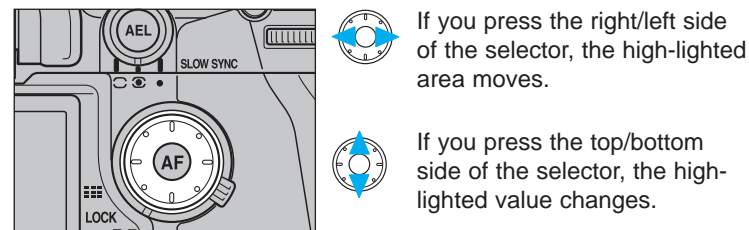
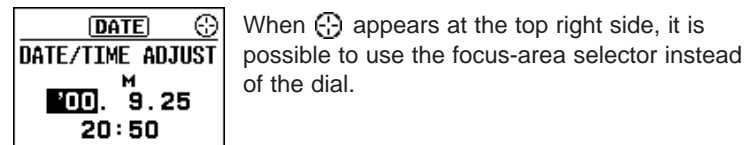

- Display returns to normal when you press the shutter-release button partway down.

After the camera batteries have been installed for two days, a second battery (non-accessable) will have been charged. This second battery will be able to provide power to retain the date/time settings for approximately 6 months should the camera's batteries be removed. After that, this message appears and the date/time information will not be imprinted, and must be set. See pages 121-122 for instructions for setting the date and time.

<<<(!)>>>

**Press [ADJ] to set date and time.**

## DATE/TIME IMPRINTING

### Changing the Format

The order of the year/month/day can be changed.

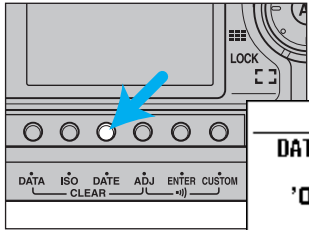
- 

1. Open the control-panel door and press the DATE button.

The date imprint window will appear in the navigation display.

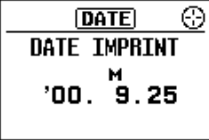
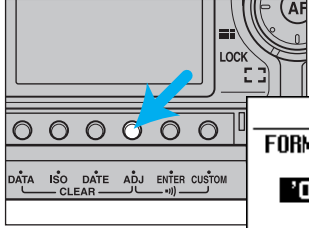
- 

2. Hold the ADJ button for 3 seconds. The year, month, and day will appear high-lighted.

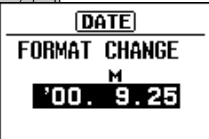
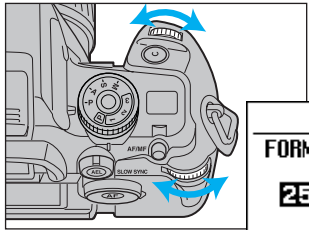
- 

3. Turn either the front or rear control dial to select the desired format.

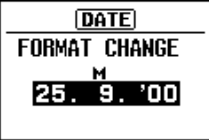

4. Press the shutter-release button partway down to save the desired format.

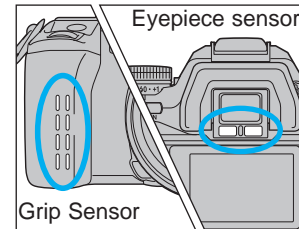
## EYE-START

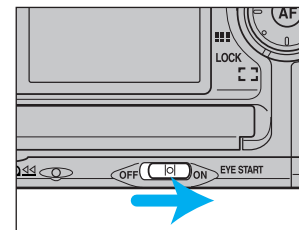

Eye-start automatically activates the camera's focus and exposure systems as you bring the camera to your eye. When an object is detected near the viewfinder, the camera's systems are activated to set the focus and exposure as you frame your subject.

### Using Eye-Start



- Slide the eye-start switch to ON.
- Turn the main switch to ON.
  - The grip sensor is activated.
- Touching the grip sensor activates the eyepiece sensor.
- When an object is detected near the viewfinder, the camera's systems are activated to set the focus and exposure as you frame your subject.
  - Autofocus and exposure systems shut down approx. five seconds after eye or grip sensor contact is broken.
  - Eye-start may not work properly when using a tripod, gloves, or if your hands are dry. In these cases, press the shutter-release button partway down to activate focus and metering.
  - Infrared absorbing sunglasses may affect eye-start operation.
  - Choose Custom 7- 2 to activate the eyepiece sensor when the main switch is in the ON position (ie; grip sensor is not used) (p.166).

## TIME EXPOSURES (BULB)



Set the shutter speed to bulb when you want to take time exposures. When selected, the shutter remains open as long as the shutter-release button is held down.

- Mount the camera on a tripod.

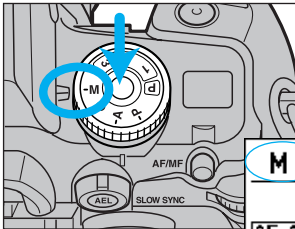

1. While pressing the exposure-mode dial lock-release button, turn the exposure-mode dial to M.

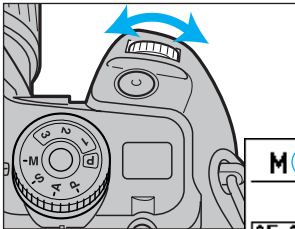
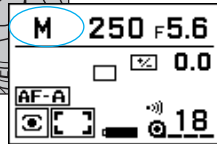

2. Turn the front control dial until BULB appears in the navigation display.

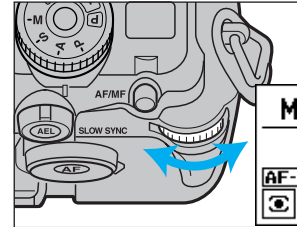
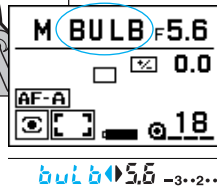

3. Turn the rear control dial to select the aperture.

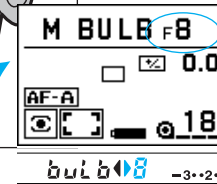

4. Compose your picture.

- If the scene is too dark for autofocus to operate, turn the focus-mode switch to MF and focus the lens manually (p. 48).

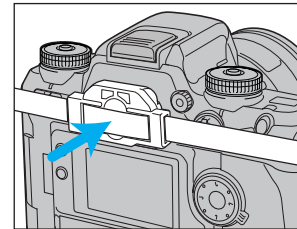

5. Cover the viewfinder with the eyepiece cap.

- The eyepiece cap prevents light from entering through the viewfinder and affecting the metered exposure.

6. Press and hold the shutter-release button to take the picture.

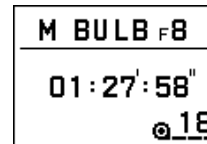

- During the time exposure, the exposure time will be shown on the navigation display.

- To reduce camera blur, attach a remote cord (p. 191).

## DEPTH-OF-FIELD PREVIEW

When the lens is focused on a subject, there is a range behind and in front of the subject that appears sharp. This is the depth-of-field. To check how much of your scene will appear in focus, press the depth-of-field preview button. The lens is stopped down to the aperture that appears in the display.

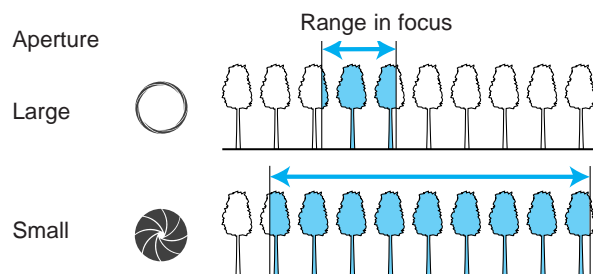

Depth-of-field can be increased by:

1. Using smaller apertures (larger f=stop numbers).
2. Using short focal length (wider angle) lenses.
3. Moving farther away from your subject.

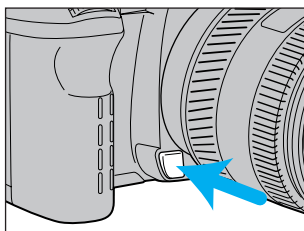

### Press the depth-of-field preview button.

- The lens will stop down to the currently selected aperture.
- The viewfinder will appear darker at larger f#s (smaller lens opening).
- The aperture can be changed while the depth-of-field preview button is pressed.

- If you press the depth-of-field preview button after pressing the shutter-release button partway down, the shutter can still be released.
- Cancel by removing your finger from the depth-of-field preview button.

- If blinks or glows in the viewfinder (ie; focus not confirmed), then the shutter cannot be released.

When using a D lens, and the depth-of-field preview button is pressed, the following information is presented in the navigation display.

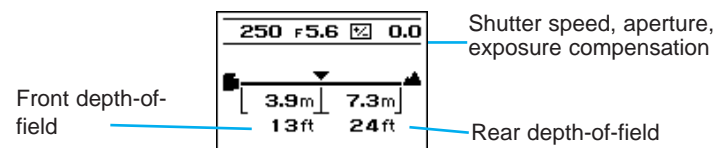

Will be shown if magnification is greater than 1:10 when using a D macro lens.

- If the D.O.F. is less than 0.01m, appears.
- If more than 20m (66ft), appears.
- If near infinity,  $\infty$  appears.

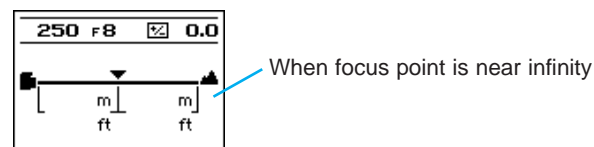
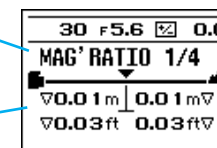

The magnification ratio is the ratio of the actual size of an object to the size of its image on the film plane.

If an object is actually 12 mm in size, and the image is also 12mm in size, then the magnification ratio is 1:1. If the image size is 6mm, then the magnification ratio is 1:2.

## DIOPTRER ADJUSTMENT

Turn the diopter adjustment dial to compensate the eyepiece for near or far sighted vision problems. The adjustment range is from -2.5 to + 0.5 diopters.

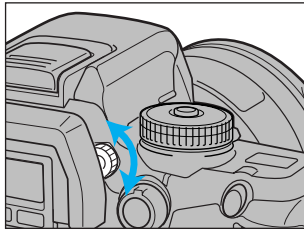

**Turn the diopter-adjustment dial until the focus frame appears sharpest.**

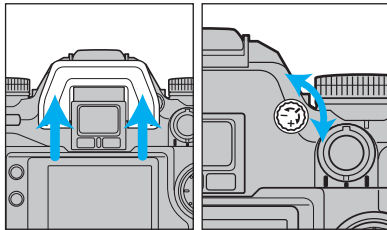

- It may be easier to adjust if the eyepiece cup is removed. Farsighted users – turn the dial clockwise. Nearsighted users – turn the dial counter-clockwise.

- For easier adjusting, before attaching the lens, look through the viewfinder at a well illuminated blank wall or clear blue sky.
- If additional correction is needed, attach a Minolta Eyepiece Corrector (optional accessory) to the camera's eyepiece. There are 4 types available for near sighted and 5 types for far sighted vision.

## SETTING/CANCELLING THE AUDIO

Your camera has the capability of producing an audio tone to let you know when focus is confirmed and locked. It can also sound when using the self-timer mode.

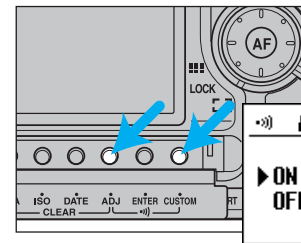

**1. Open the control-panel door and simultaneously press the ADJ and CUSTOM buttons.**

- The audio set display will appear.

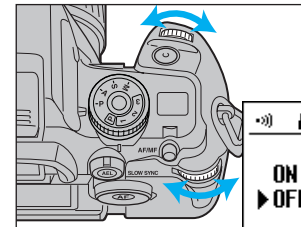

**2. Turn either the front or rear control dial to select audio ON or OFF.**

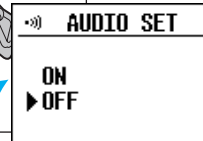

- The navigation display returns to the previous display when the shutter-release button is pressed partway down. appears when audio is selected.

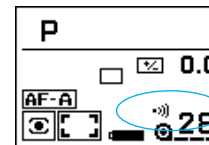

- When audio ON is selected, a tone will be heard when;
  - Focus is confirmed - 2 short beeps, except when the subject is moving, or when AF-C is set.
  - Self-timer countdown - will beep slowly at first, then rapidly, and finally a solid tone just before the shutter releases.